

Operating Manual

Translation of the original instructions



PowerLossMonitor PLM

PLM 2, PLM 10, PLM 20, PLM 40

PowerMonitorSoftware PMS

IMPORTANT!

READ CAREFULLY BEFORE USE.

KEEP FOR FUTURE USE.

Table of contents

1	Basic safety instructions	7
2	Symbol explanations	9
3	Conditions at the installation site	9
4	Introduction	10
4.1	System description	10
4.2	Measuring principle	10
4.3	Configurations.....	11
5	Transport	12
6	Installing the software	12
7	Connecting the cooling circuit	13
7.1	Water quality	13
7.2	Water pressure.....	13
7.3	Humidity.....	14
7.4	Water connections and water flow rate.....	15
7.5	Cooling circuit connections on the PLM 2	15
7.6	Cooling circuit connections on the PLM 10 and PLM 20	15
7.7	Cooling circuit connections on the PLM 40	16
7.8	Influence of the hose lengths on the time constants for measuring devices with external temperature sensor	16
8	Electrical connection	17
8.1	Electrical connections on the PLM 2.....	17
8.2	Electrical connections on the PLM 10 and PLM 20	18
8.3	Electrical connections on the PLM 40.....	19
8.3.1	Toggle switch to switch between external and internal temperature sensor	19
8.4	Connect the safety interlock.....	20
8.5	Connect the power supply	21
8.6	PIRMES bus.....	21
8.7	Connect the external temperature sensor.....	21
8.8	Connect the PC via the RS232 interface	22
8.9	Connect the PC via the USB interface.....	23
8.10	Analog output	24
9	Installation of the external temperature sensor	24
10	Measurement	25
10.1	Display the measuring values in the display or the PowerMonitorSoftware PMS	25
10.2	Measuring value display	25
10.3	LED „Error“	25
10.4	Tare weight compensation to balance out various resistance values of the temperature sensors	25
11	Storage	26
12	Maintenance and service	26
13	Measures for the product disposal	26
14	Declaration of conformity	27
15	Technical data	28

16	Dimensions	29
16.1	Dimensions PLM 2.....	29
16.2	Dimensions PLM 10.....	30
16.3	Dimensions PLM 20.....	31
16.4	Dimensions PLM 40.....	32

PRIMES - The Company

PRIMES manufactures measuring devices used to analyze laser beams. These devices are employed for the diagnostics of high-power lasers ranging from CO₂ lasers and solid-state lasers to diode lasers. A wavelength range from infrared through to near UV is covered, offering a wide variety of measuring devices to determine the following beam parameters:

- Laser power
- Beam dimensions and position of an unfocused beam
- Beam dimensions and position of a focused beam
- Beam quality factor M^2

PRIMES is responsible for both the development, production, and calibration of the measuring devices. This guarantees optimum quality, excellent service, and a short reaction time, providing the basis for us to meet all of our customers' requirements quickly and reliably.



PRIMES GmbH
Max-Planck-Str. 2
64319 Pfungstadt
Germany

Tel +49 6157 9878-0
info@primes.de
www.primes.de

1 Basic safety instructions

Intended use

The PowerLossMonitor PLM is used to determine power losses at water-cooled optical components of a laser beam guidance. Please mind and adhere to the specifications and limit values given in chapter 15, „Technical data“, on page 28. Other forms of usage are improper. Other uses are considered to be improper. The information contained in this operating manual must be strictly observed to ensure proper use of the device.

Using the device for unspecified use is strictly prohibited by the manufacturer. By usage other than intended the device can be damaged or destroyed. This poses an increased health hazard up to fatal injuries. When operating the device, it must be ensured that there are no potential hazards to human health.

The device does not emit any laser radiation. However, the device is installed in close proximity to laser beam systems. Hence, valid safety regulations are to be observed and necessary safety measures are to be taken.

In measuring mode, the laser control's safety interlock must be connected with the device.

Observing applicable safety regulations

Please observe valid national and international safety regulations as stipulated in ISO/CEN/TR standards as well as in the IEC-60825-1 regulation, in ANSI Z 136 "Laser Safety Standards" and ANSI Z 136.1 "Safe Use of Lasers", published by the American National Standards Institute, and additional publications, such as the "Laser Safety Basics", the "LIA Laser Safety Guide", the "Guide for the Selection of Laser Eye Protection" and the "Laser Safety Bulletin", published by the Laser Institute of America, as well as the "Guide of Control of Laser Hazards" by ACGIH.

Necessary safety measures

If people are present within the danger zone of visible or invisible laser radiation, for example near laser systems that are only partly covered, open beam guidance systems, or laser processing areas, the following safety measures must be implemented:

- Connect the laser control's safety interlock to the device. Check that the safety interlock will switch off the laser properly in case of error.
- Please wear **safety goggles** adapted to the power, power density, laser wave length and operating mode of the laser beam source in use.
- Depending on the laser source, it may be necessary to wear suitable **protective clothing** or **protective gloves**.
- Protect yourself from direct laser radiation, scattered radiation, and beams generated from laser radiation (by using appropriate shielding walls, for example, or by weakening the radiation to a harmless level).
- Use beam guidance or beam absorber elements that do not emit any hazardous substances when they come in to contact with laser radiation and that can withstand the beam sufficiently.
- Install safety switches and/or emergency safety mechanisms that enable immediate closure of the laser shutter.

Employing qualified personnel

The device may only be operated by qualified personnel. The qualified personnel must have been instructed in the installation and operation of the device and must have a basic understanding of working with high-power lasers, beam guiding systems and focusing units.

Conversions and modifications

The device must not be modified, neither constructionally nor safety-related, without our explicit permission. The device must not be opened e.g. to carry out unauthorized repairs. Modifications of any kind will result in the exclusion of our liability for resulting damages.

Liability disclaimer

The manufacturer and the distributor of the measuring devices do not claim liability for damages or injuries of any kind resulting from an improper use or handling of the devices or the associated software. Neither the manufacturer nor the distributor can be held liable by the buyer or the user for damages to people, material or financial losses due to a direct or indirect use of the measuring devices.

2 Symbol explanations

The following symbols and signal words indicate possible residual risks:



DANGER

Means that death or serious physical injuries **will** occur if necessary safety precautions are not taken.



WARNING

Means that death or serious physical injuries **may** occur if necessary safety precautions are not taken.



CAUTION

Means that minor physical injury **may** occur if necessary safety precautions are not taken.

NOTICE

Means that property damage **may** occur if necessary safety precautions are not taken.

The following symbols indicating requirements and possible dangers are used on the device:



Read and observe the operating instructions and safety guidelines before startup!

Further symbols that are not safety-related:



Here you can find useful information and helpful tips.



With the CE designation, the manufacturer guarantees that its product meets the requirements of the relevant EC guidelines.

- ▶ Call for action

3 Conditions at the installation site

- The device must not be operated in a condensing atmosphere.
- The ambient air must be free of organic gases.
- Protect the device from splashes of water and dust.
- Operate the device in closed rooms only.

4 Introduction

4.1 System description

The PowerLossMonitor PLM is a system that determines power losses especially in water-cooled components of beam guidance systems.

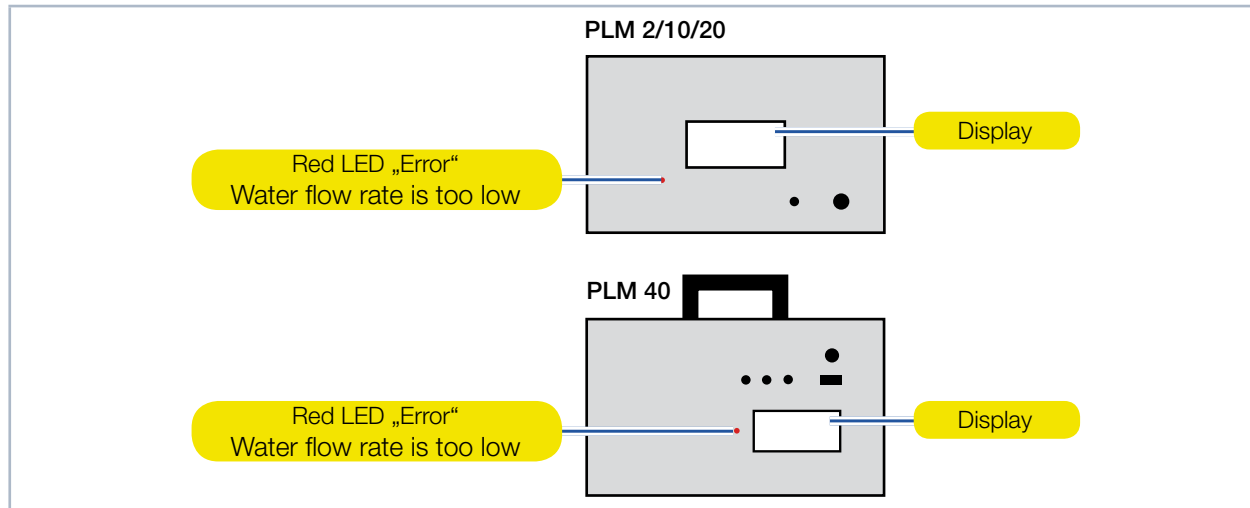

Fig. 4.1: Components of the PowerLossMonitor PLM

4.2 Measuring principle

The PowerLossMonitor PLM measures the water flow rate of the cooling water as well as the temperature difference between inflowing and outflowing water. These values are then used to calculate the power induced in the cooling water.

If the mounting of the beam deflection mirrors is thermally insulated from the machine frame, the measured power equals the power that was converted into heat by the mirrors exactly.

Since in reality this is, however, not possible, heat constantly leaks from the machine frame into the cooling water (or vice versa). This results in a zero offset. Therefore, the zero value has to be subtracted from the measured value to determine the power loss.

The main components of the measuring system include:

- Housing including electronic measuring equipment, LCD display and connections
- Integrated temperature sensor
- External temperature sensor
- Integrated flow meter

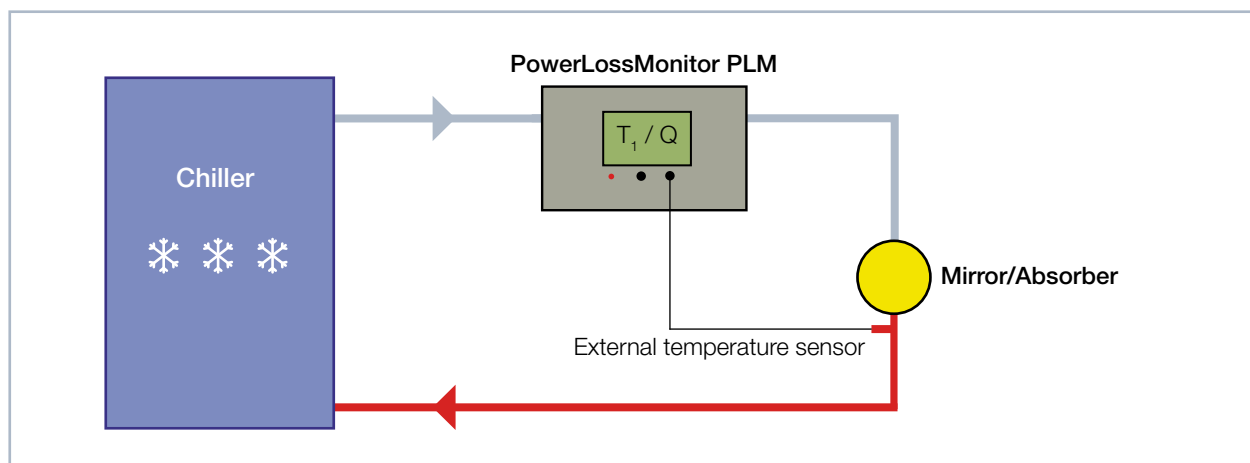

Fig. 4.2: Schematic representation of the measurement setup with external temperature sensor

4.3 Configurations

Depending on the purpose of use and power, the devices are available with different configurations and connections:

Designation	Connections	Power in kW
PLM 2		2
PLM 10		10
PLM 20		20
PLM 40		40

Tab. 4.1: PowerLossMonitor PLM configurations

5 Transport

NOTICE

Damaging/destroying the device

Hard hits or falls may damage the device.

- ▶ Handle the device carefully when transporting it.
 - ▶ Only transport the device in the original PRIMES transport box.
-

NOTICE

Damage/destruction of the device caused by leaking or freezing cooling water

Leaking cooling water can damage the device. Transporting the device at temperatures near or below freezing and without emptying the cooling circuit completely can damage the device.

- ▶ Empty the lines of the cooling circuit completely.
 - ▶ Even when the lines of the cooling circuit have been emptied, a small amount of residual water will remain in the device at all times. This may leak out and end up inside the device. Close the connector plug of the cooling circuit with the included sealing plug.
-

NOTICE

Damaging/Destruction of the flow rate meter

The flow rate meter is not designated for high rotational speed.

- ▶ Do not use compressed air for emptying the cooling circuit.
-

6 Installing the software

For the operation of a PowerLossMonitor PLM with a PC, the PRIMES PowerMonitorSoftware has to be installed. Start the installation by double-clicking the file "PMS v.2.xx Setup" and follow the instructions on your screen.

7 Connecting the cooling circuit



DANGER

Fire hazard; Damage/Destruction of the device due to overheating

If there is no water cooling or a water flow rate which is insufficient, there is a danger of overheating, which can damage the device or set it on fire.

- ▶ Do not operate the device without a connected water cooling. Ensure a sufficient water flow rate.

7.1 Water quality

NOTICE

Damage/Destruction of the device due to different chemical potentials

The parts of the device which get in contact with cooling water consist of copper, brass or stainless steel. A connection of the device to aluminum pipes can lead to corrosion of the aluminum due to the different chemical potentials.

- ▶ Do not connect the device with a cooling circuit made of aluminium.

- The device can be operated with tap water as well as demineralized water.
- Do not operate the device on a cooling circuit containing additives such as anti-freeze.
- Do not operate the device on a cooling circuit in which aluminum components are installed. Especially when it comes to the operation with high powers and power densities, it may otherwise lead to corrosion in the cooling circuit. In the long term, this reduces the efficiency of the cooling circuit.
- Should the cooling fail, the device can withstand the laser radiation for a few seconds. In this case, please check the device as well as the water connections for damages and replace them if necessary.
- Large dirt particles or teflon tape may block internal cooling circuits. Therefore, please thoroughly rinse the system before connecting it.

7.2 Water pressure

NOTICE

Damage/Destruction of the device due to overpressure

- ▶ The maximum allowable water pressure differs for the versions of the PowerLossMonitor PLM. You can find the necessary water pressure in chapter 15, „Technical data“, on page 28.

7.3 Humidity

- The device must not be operated in a condensing atmosphere. The humidity has to be considered in order to prevent condensates within and outside the device.
- The temperature of the cooling water must not be lower than the dew point (see Tab. 7.1 on page 14).

NOTICE

Damage/Destruction of the device due to condensing water

Condensation water inside of the device can lead to damage.

► **Mind the dew-point in Tab. 7.1 on page 14.**

Do only cool the device during the measuring operation. We recommend starting the cooling approx. 2 minutes before the measurement and terminating it approx. 1 minute after the measurement.

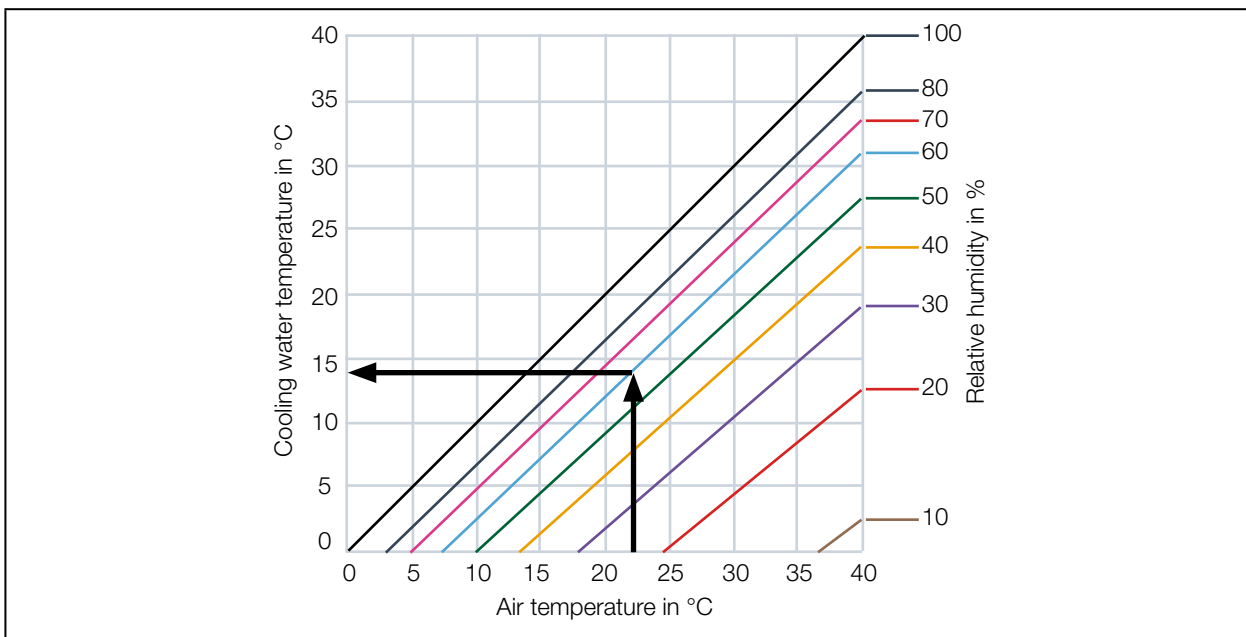

Tab. 7.1: Dew point diagram

Example

Air Temperature: 22 °C
 Relative Humidity: 60 %

The cooling water temperature cannot fall below 14 °C.

7.4 Water connections and water flow rate

The devices have the following outside port diameters. To ensure a reliable operation, the water flow rate according to Tab. 7.2 on page 15 is required. When the minimum flow rate is not met, the laser will be turned off if a safety interlock is connected.

	PLM 2	PLM 10	PLM 20	PLM 40
Connection outer diameter for PE hoses	8 mm	12 mm	16 mm	3/4 Zoll
Recommended flow rate in l/min	1 – 4	7 – 12	10 – 22	20 – 37
Minimum flow rate in l/min	0.5	4	4	8

Tab. 7.2: Water connection outer diameter and cooling water flow rate

7.5 Cooling circuit connections on the PLM 2

Outside port diameter for PE hose 8 mm

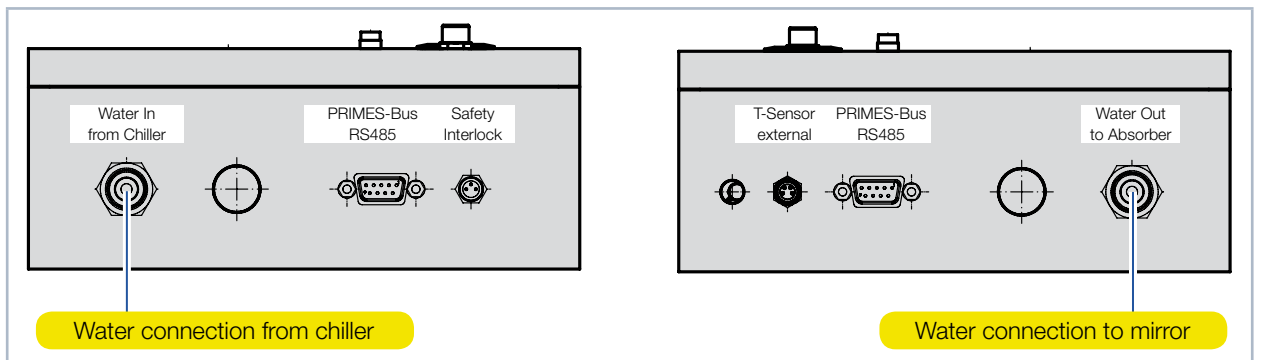

Fig. 7.1: Water connections PLM 2

7.6 Cooling circuit connections on the PLM 10 and PLM 20

Outside port diameter for PE hose 12 mm (PLM 10) and 16 mm (PLM 20)

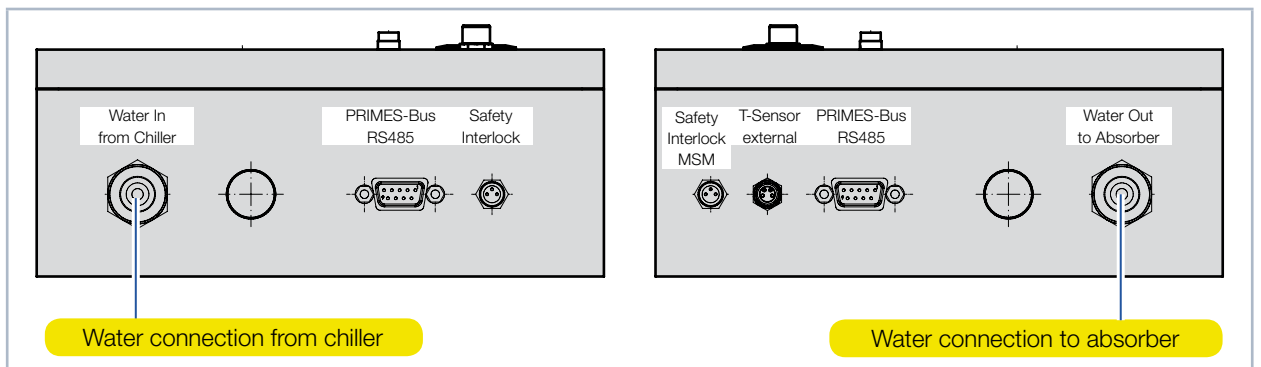

Fig. 7.2: Water connections PLM 10 and PLM 20

7.7 Cooling circuit connections on the PLM 40

Outside port diameter for PE hose 3/4 inches



When fastening the coupling nut, make sure to use an open-end wrench AF 36 to prevent the screwing inside the housing from loosening.



Fig. 7.3: Water connections PLM 40

7.8 Influence of the hose lengths on the time constants for measuring devices with external temperature sensor



The lengths of the hose connections have an influence on the time constants of the measuring devices. Please only use the provided hoses at the positions marked with red arrows.

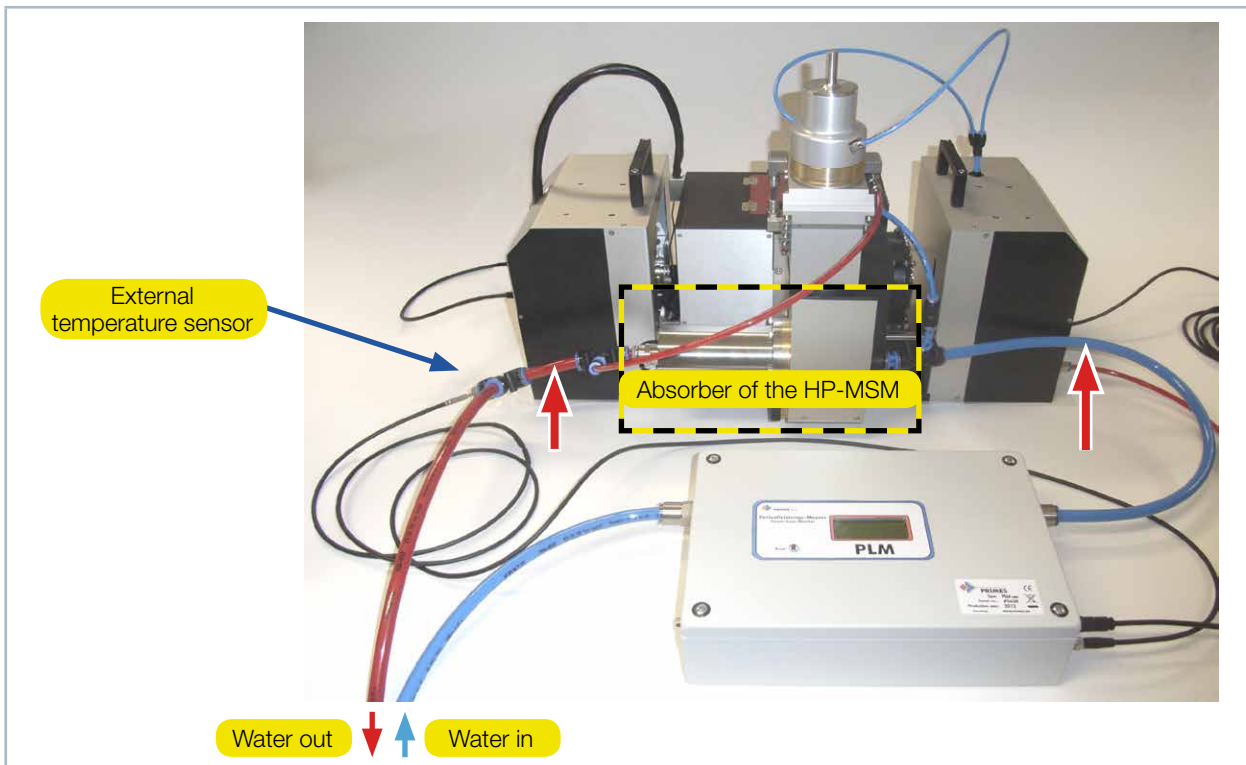

Fig. 7.4: Cooling Circuit PLM 10 with external temperature sensor with the example of the HP-MSM

8 Electrical connection

The measuring device has the following electrical connections:

- Connection for the external temperature sensor (T-Sensor external)
- Safety interlock connection in order to control the water flow rate (safety Interlock and safety interlock MSM respectively)
- PRIMES bus connections (D-Sub sockets, 9-pin) for the power supply and communication
- USB interface
- Analog output 0 V ... 10 V

8.1 Electrical connections on the PLM 2

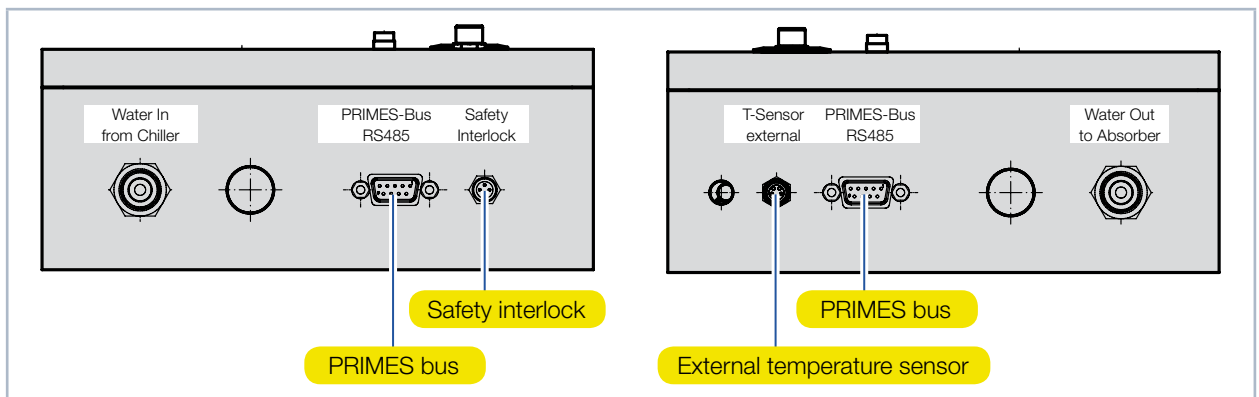

Fig. 8.1: Electrical connections PLM 2 at the side

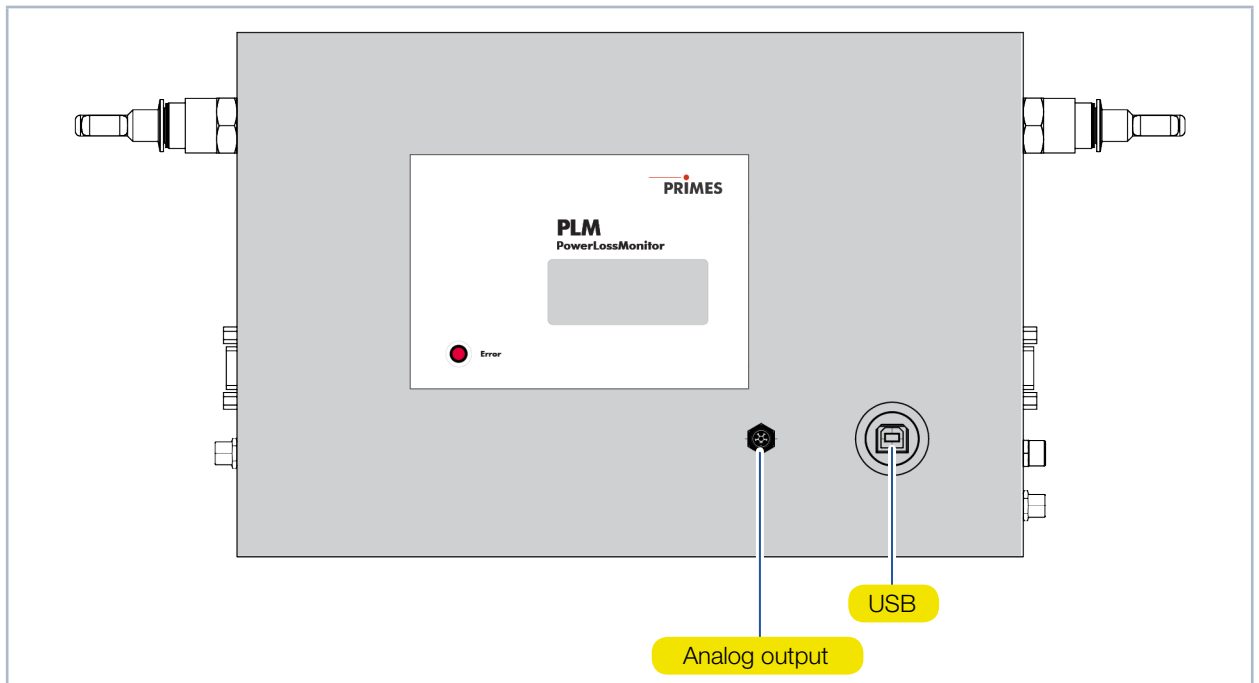

Fig. 8.2: Electrical connections PLM 2 at the cover plate

8.2 Electrical connections on the PLM 10 and PLM 20

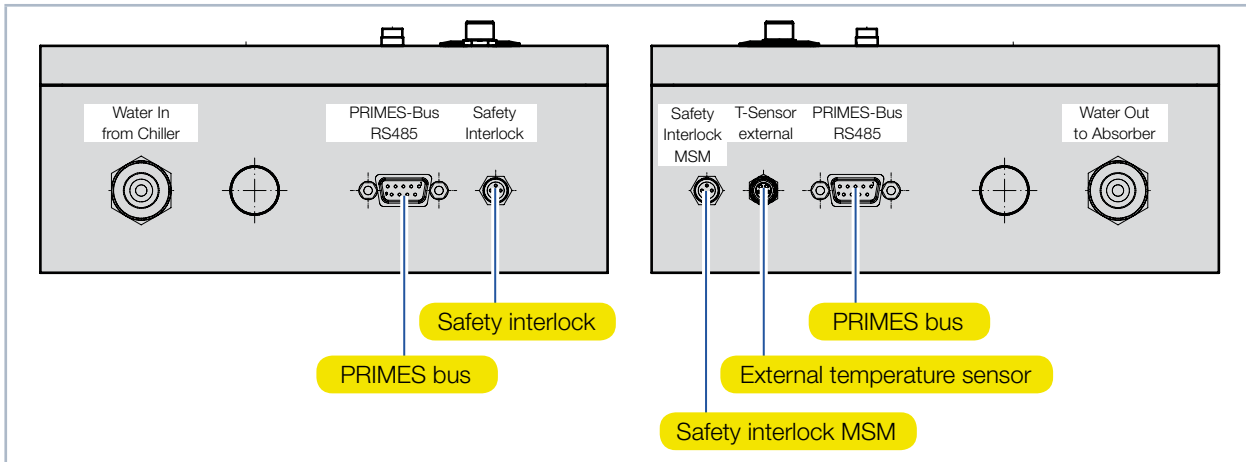

Fig. 8.3: Electrical connections PLM 10 and PLM 20 at the side

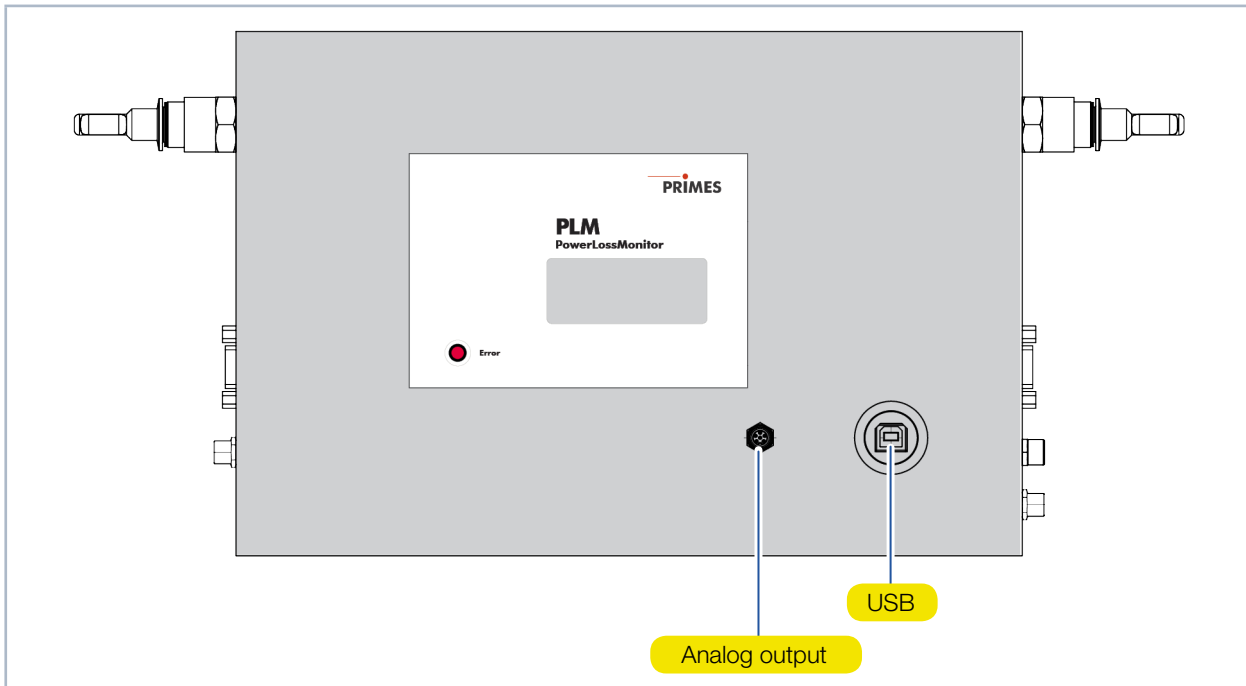

Fig. 8.4: Electrical connections PLM 10 and PLM 20 at the cover plate

8.3 Electrical connections on the PLM 40

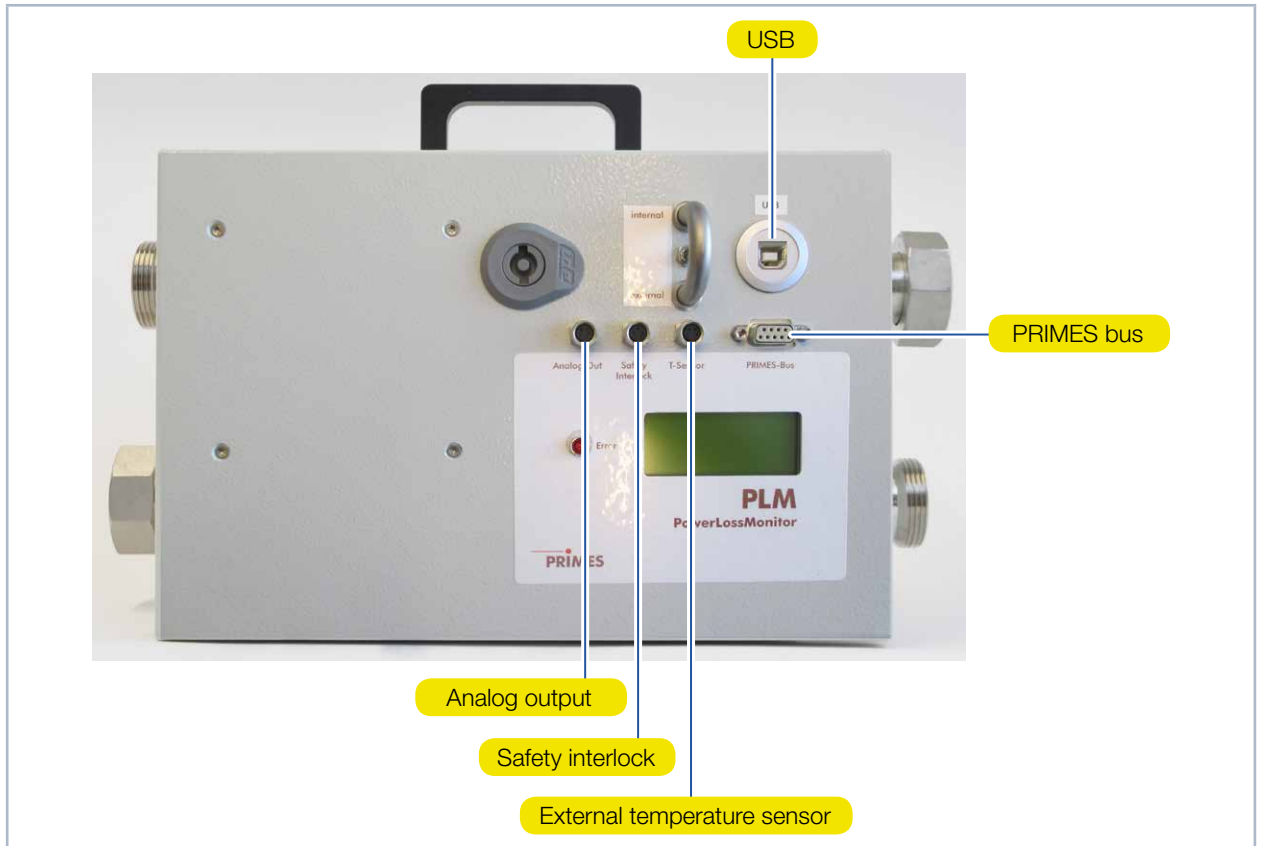

Fig. 8.5: Electrical connections PLM 40

8.3.1 Toggle switch to switch between external and internal temperature sensor

You can switch between the external and internal temperature sensor in the return flow of the cooling water by means of the toggle switch extern/intern (see Fig. 8.6 on page 19).

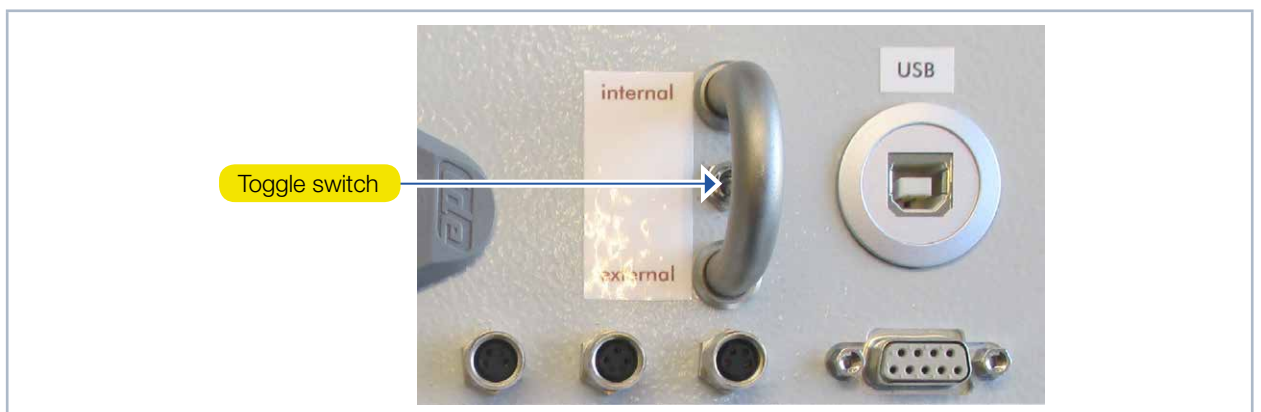

Fig. 8.6: Switch for temperature measuring points

8.4 Connect the safety interlock

The safety interlock protects the measuring device from damages by turning off the laser in case of an error. The device can be damaged in case of a low water flow rate.

Whenever the water flow rate is too low, pins 1 and 4 are connected. In case the water flow rate is according to the operating conditions, pins 1 and 3 are connected.

NOTICE

Damaging/Destruction of the device

If the safety interlock is not connected, this may lead to damages to the device due to overheating.

- ▶ **Make sure to connect the laser control in a way that ensures that the laser is turned off whenever this connection is interrupted.**

A suitable connection cable with a device plug and free ends is included in the scope of delivery

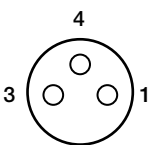
Pin assignment socket (top view, plug-in side)	Pin	Wire color	Function
	1	Brown	Mutual pin
	3	Blue	Connected with Pin 1 when ready for operation
	4	Black	Connected with Pin 1 when in safety interlock mode (water flow rate too low)

Tab. 8.1: Pin assignment safety interlock

8.5 Connect the power supply

In order to operate, the PowerLossMonitor PLM requires a supply voltage of 24 V \pm 5 % (DC). A suitable power supply with an adapter unit is included in the scope of delivery. Please use only the provided connection lines.

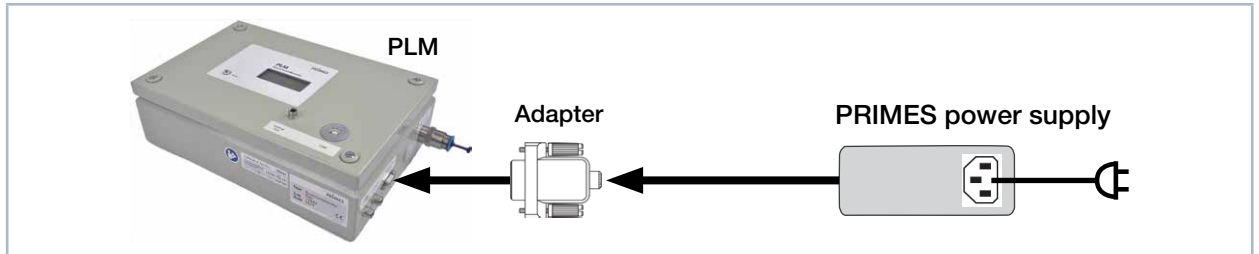
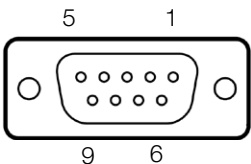

Fig. 8.7: Connecting the power supply

Connect the power supply unit via the adapter with one of the 9 pin D-Sub sockets (RS485) of the PowerLossMonitor PLM.

8.6 PRIMES bus

The device is supplied with power by means of the 9 pin D-Sub sockets. Using a converter, the socket can also be used to connect a PC to enable communication (see chapter 8.8 on page 22).

D-Sub socket, 9 pin (top view, plug-in side)	Pin	Function
	1	Ground
	2	RS485 (+)
	3	+24 V
	4	Not assigned
	5	Not assigned
	6	Ground
	7	RS485 (-)
	8	+24 V
	9	Not assigned

Tab. 8.2: Pin assignment PRIMES bus

8.7 Connect the external temperature sensor

The temperature sensor is a Pt100 with a four-wire connection. Plug the connector cable into the corresponding socket of the PowerLossMonitor PLM. The connection cable may have a length of up to 10 m.

8.8 Connect the PC via the RS232 interface

For the communication with the computer, you require:



Fig. 8.8: Scope of delivery

NOTICE

Damaging/Destruction of the device

Connecting or disconnecting the bus cable when it is connected with the supply voltage leads to voltage peaks, which may damage communication modules of the measuring device.

- ▶ Only establish connections when the power supply unit is turned off! Do not disconnect anything as long as the supply voltage is turned on!

NOTICE

Damaging/Destruction of the device

The supply voltage of 24 V is ensured by means of the RS485-based PRIMES bus. If the measuring device is directly connected with a PC, the computer may be damaged!

- ▶ Only connect your PC with the measuring system via a PRIMES RS485/RS232 interface converter.

1. Connect the device with the PRIMES converter via the PRIMES connector cable (plug/plug).
2. Connect the PC with the PRIMES converter via the PRIMES connector cable (socket/socket).
3. Use the adapter to connect the power supply to the 9-pin D sub socket (RS485) of the device.

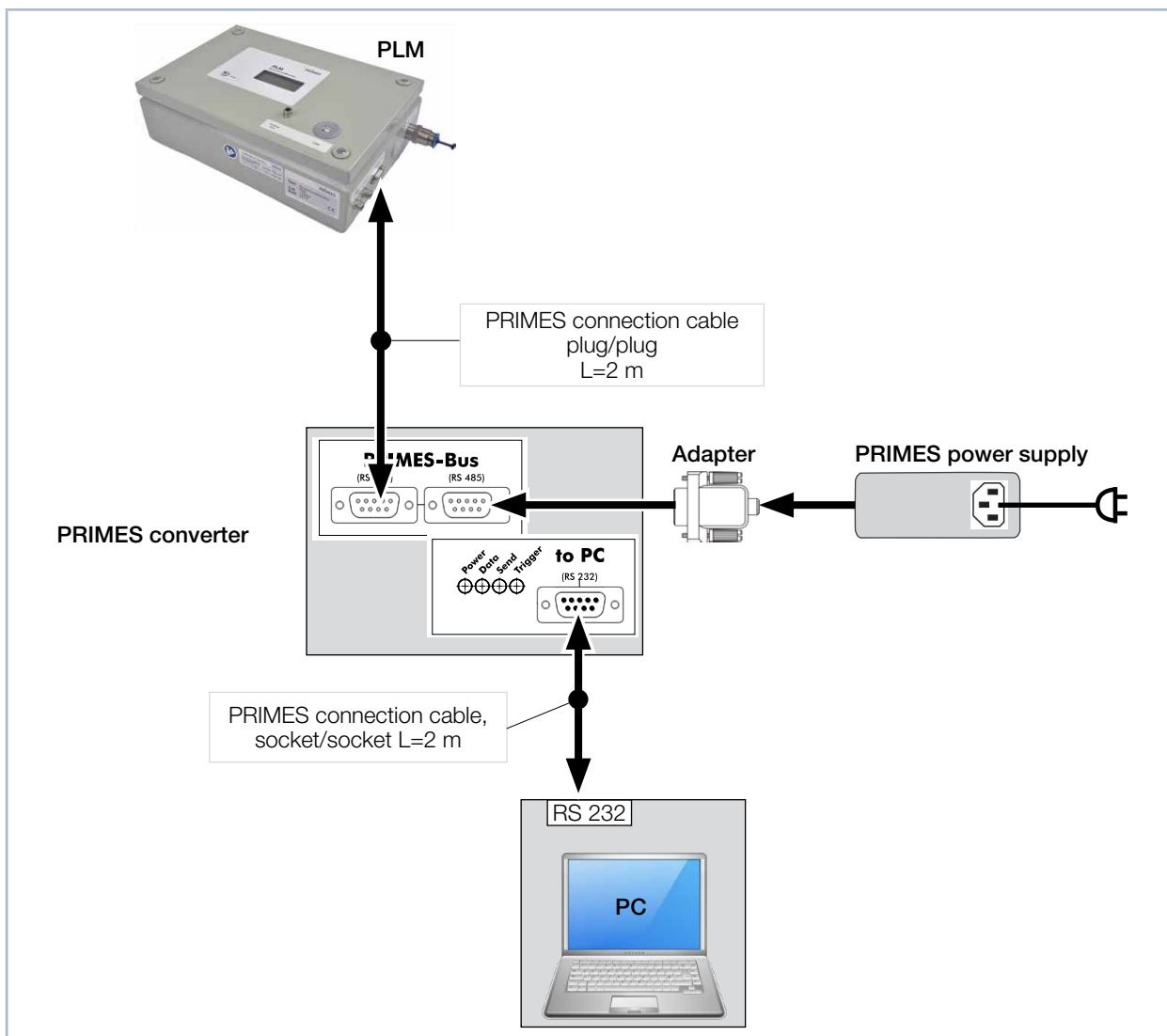

Fig. 8.9: Connection with the PC via RS232 and PRIMES converter

8.9 Connect the PC via the USB interface

You can also connect the PC via the USB interface of the PowerLossMonitor PLM. In this case, the PRIMES-RS485/RS232 converter is not needed and the power supply is connected directly via an adapter to the PowerLossMonitor PLM (see Fig. 8.2 on page 17 or Fig. 8.4 on page 18 and Fig. 8.5 on page 19).

You will find the PRIMES USB-driver for all USB-capable devices on the PRIMES website at: <https://www.primes.de/en/support/downloads/software.html>.

8.10 Analog output

The analog signal is effected via the 4-pin device socket M8 (see Fig. 8.2 on page 17 or Fig. 8.4 on page 18 and Fig. 8.5 on page 19). The output voltage is 0 V ...10 V. A suitable connection cable is included in the scope of delivery.

	PLM 2	PLM 10	PLM 20	PLM 40
An output voltage of 1 V equals approx.	250 W	1000 W	2000 W	4000 W

Tab. 8.3: Output voltage and laser power

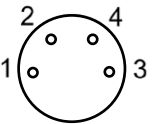
Pin assignment socket (top view, plug-in side)	Pin	Wire color	Function
	1	Brown	Not connected
	2	White	Not connected
	3	Blue	Ground for the analog signal
	4	Black	Analog signal 0-10 Volt

Tab. 8.4: Socket assignment of the analog output

9 Installation of the external temperature sensor

The temperature sensor has to be installed in a way that ensures that it extends into the water flow but against the flow direction. The tip should protrude from the bottom of the pipe approximately 15 mm.

1. Plug the external temperature sensor into the cooling circuit output using a T-piece (see Fig. 7.4 on page 16).
- The temperature sensor should be positioned as close to the cooling circuit output of the mirror or the absorber as possible.

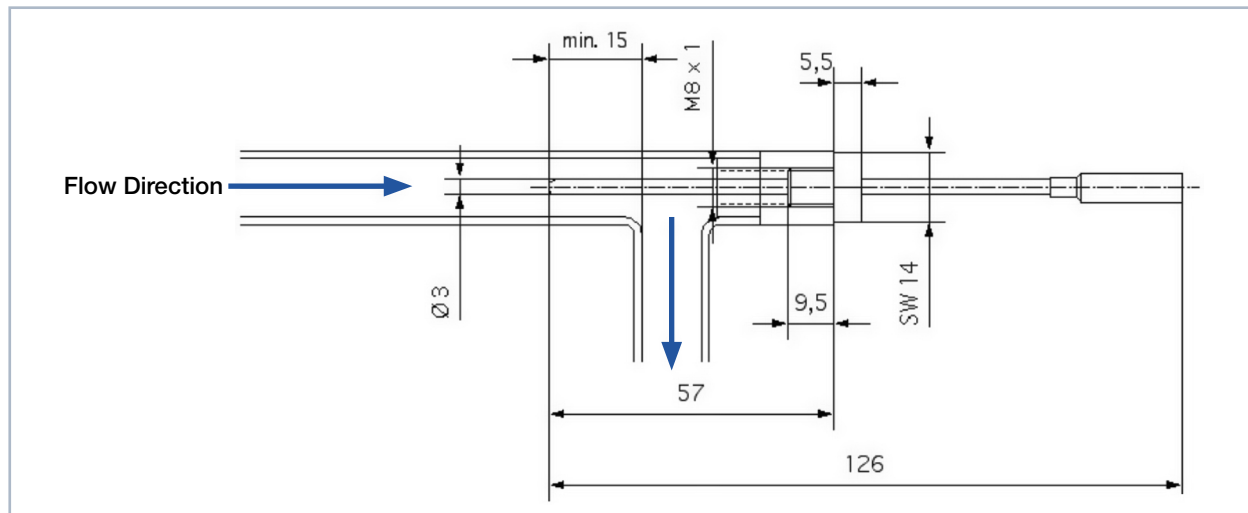

Fig. 9.1: Installation of the external temperature sensor

10 Measurement

Please observe the safety instructions in Chapter 1 on page 7.

10.1 Display the measuring values in the display or the PowerMonitorSoftware PMS

The measured values are displayed on the integrated display or can also be displayed on a PC via the PRIMES bus or the USB-interface. This requires the PRIMES PowerMonitorSoftware PMS (included in the scope of delivery).

10.2 Measuring value display

The following measuring values are displayed:

- Absolute temperature
- Temperature difference
- Flow rate of the cooling agent
- Calculated power loss

10.3 LED „Error“

The red LED glows if the water flow rate is too low.

Switch the laser off in this case and check the minimum flow-through volume.

10.4 Tare weight compensation to balance out various resistance values of the temperature sensors

For technical reasons, different resistance values in the temperature sensors can occur (depending on the cable length and the contact resistance), which can lead to different power displays when the laser is switched off.

The PRIMES PowerMonitorSoftware PMS offers the possibility to adjust this „offset“ before a measurement (tare adjustment).

Click on the button **Use current value as offset** before measurement.

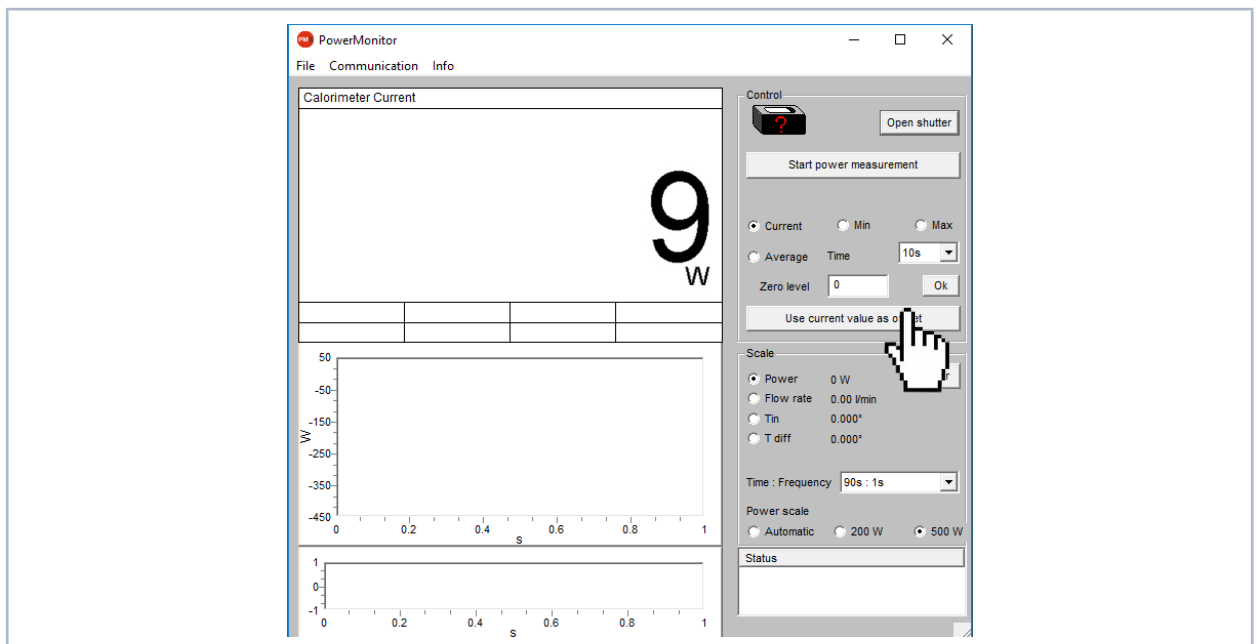

Fig. 10.1: User interface of the PowerMonitorSoftware PMS

11 Storage

Please note before storing:

NOTICE

Damage/destruction of the device caused by leaking or freezing cooling water

Leaking cooling water can damage the device. Storing the device at temperatures near or below freezing and without emptying the cooling circuit completely can damage the device.

- ▶ Empty the lines of the cooling circuit completely.
- ▶ Even when the lines of the cooling circuit have been emptied, a small amount of residual water will remain in the device at all times. This may leak out and end up inside the device. Close the connector plug of the cooling circuit with the included sealing plug.
- ▶ Store the device in the original PRIMES transport box.

NOTICE

Damaging/Destruction of the flow rate meter

The flow rate meter is not designated for high rotational speed.

- ▶ Do not use compressed air for emptying the cooling circuit.

12 Maintenance and service

The operator is responsible for determining the maintenance intervals for the measuring device. PRIMES recommends a maintenance interval of 12 months for inspection and validation or calibration. If the device is used only sporadically, the maintenance interval can also be extended up to 24 months.

13 Measures for the product disposal

Due to the Electrical and Electronic Equipment Act ("Elektro-G") PRIMES is obliged to dispose PRIMES measuring devices manufactured after August, 2005, free of charge. PRIMES is a registered manufacturer in the German "Used Appliances Register" (Elektro-Altgeräte-Register "EAR") with the number WEEE-Reg.-Nr. DE65549202.

Provided that you are located in the EU, you are welcome to send your PRIMES devices to the following address where they will be disposed free of charge (this service does not include shipping costs):

PRIMES GmbH
Max-Planck-Str. 2
64319 Pfungstadt
Germany

14 Declaration of conformity

Original EG Declaration of Conformity

The manufacturer: PRIMES GmbH, Max-Planck-Straße 2, 64319 Pfungstadt, Germany,
hereby declares that the device with the designation:

PowerLossMonitor (PLM)

Types: PLM

is in conformity with the following relevant EC Directives:

- EMC Directive EMC 2014/30/EU
- Low voltage Directive 2014/35/EU
- Directive 2011/65/EC on the restriction of the use of certain hazardous substances (RoHS) in electrical and electronic equipment

Authorized for the documentation:
PRIMES GmbH, Max-Planck-Straße 2, 64319 Pfungstadt, Germany

The manufacturer obligates himself to provide the national authority in charge with technical documents in response to a duly substantiated request within an adequate period of time.

Pfungstadt, April 26, 2017



Dr. Reinhard Kramer, CEO

15 Technical data

Measurement parameters	PLM 2	PLM 10	PLM 20	PLM 40
Max. laser power	2 kW	10 kW	20 kW	40 kW
Resolution temperature measurement	0,001 K			
Resolution power measurement	1 W			
Supply data	PLM 2	PLM 10	PLM 20	PLM 40
Power supply, DC	24 V ± 5 %			
Current demand	< 800 mA			
Max. cooling water pressure	3 bar	4 bar	5 bar	5 bar
Recommended cooling water flow rate	1 – 4 l/min	7 – 12 l/min	10 – 22 l/min	20 – 37 l/min
Cooling water temperature $T_{in}^{1)}$	Dew point temperatur < T_{in} < 30 °C			
¹⁾ Please contact PRIMES in advance in case you intend not to work within this specification.				
Communication	PLM 2	PLM 10	PLM 20	PLM 40
Interfaces	2 x RS485 1 x USB	2 x RS485 1 x USB	2 x RS485 1 x USB	1 x RS485 1 x USB
Dimensions and weight	PLM 2	PLM 10	PLM 20	PLM 40
Dimensions (LxWxH) without connections	300 x 200 x 80 mm	300 x 200 x 80 mm	300 x 200 x 80 mm	304 x 200 x 146 mm
Weight, approx.	3.8 kg	3.8 kg	3.8 kg	6.7 kg

16 Dimensions

16.1 Dimensions PLM 2

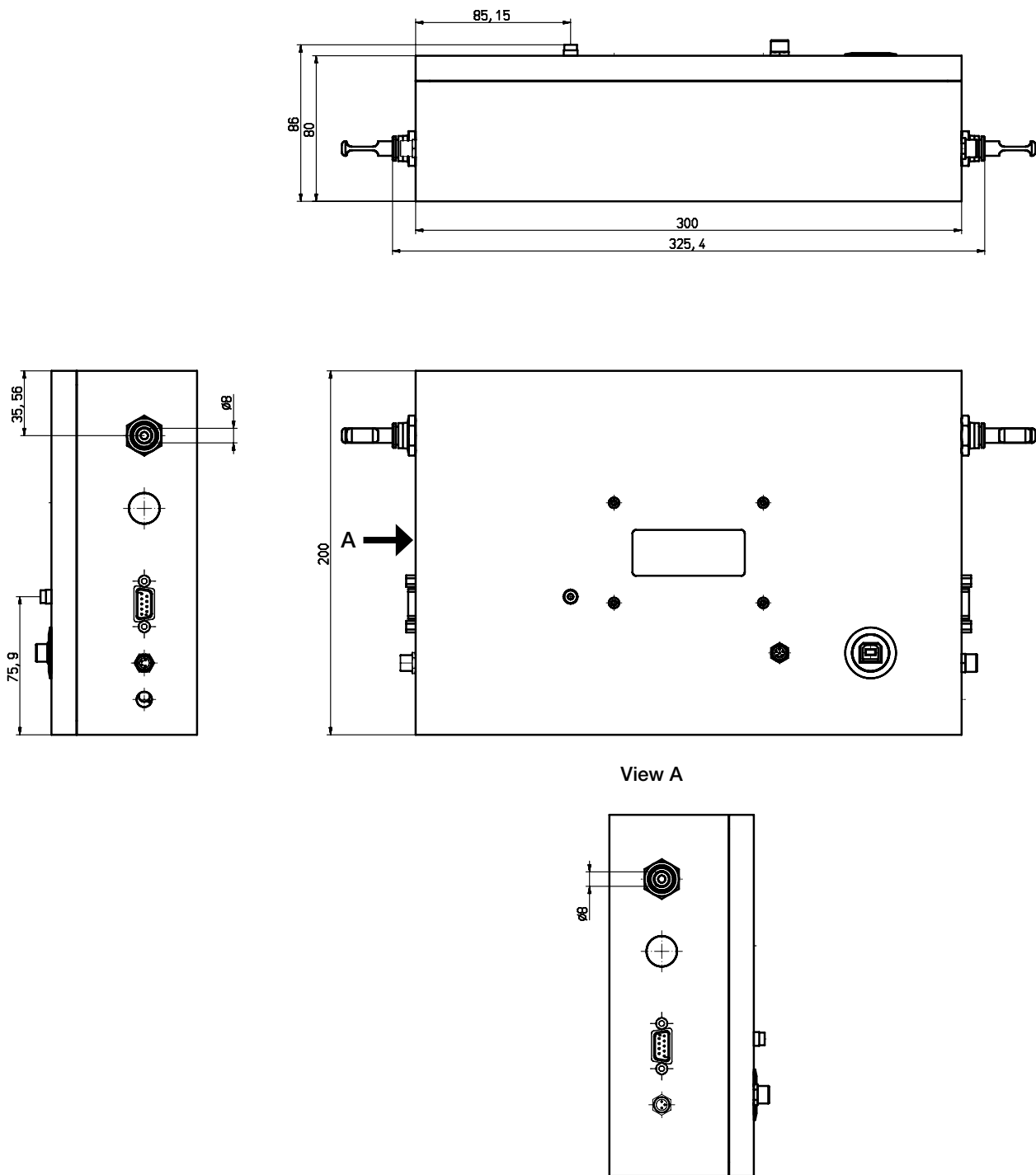

All dimensions in mm (general tolerance ISO 2768-v)

16.2 Dimensions PLM 10

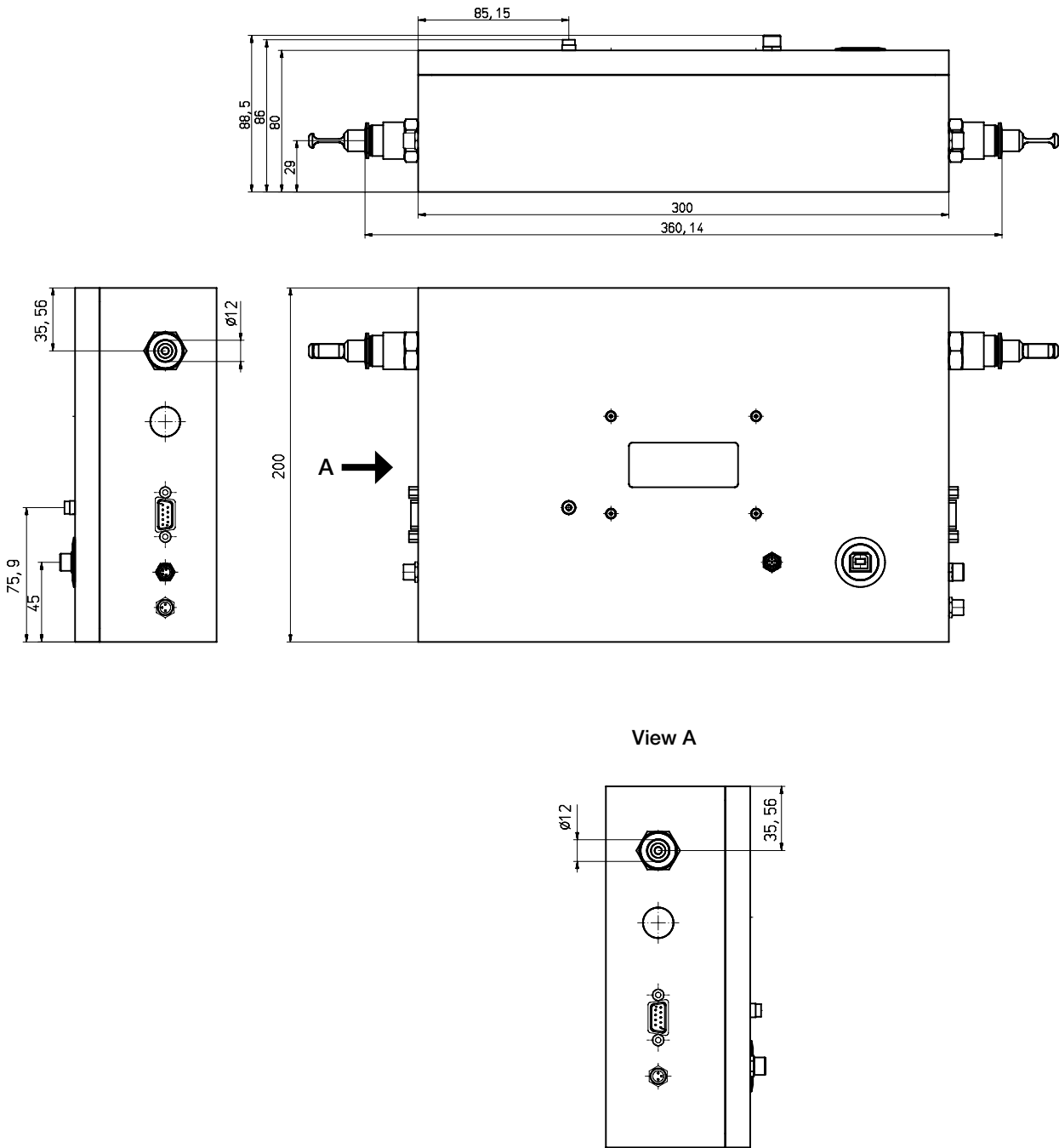

All dimensions in mm (general tolerance ISO 2768-v)

16.3 Dimensions PLM 20

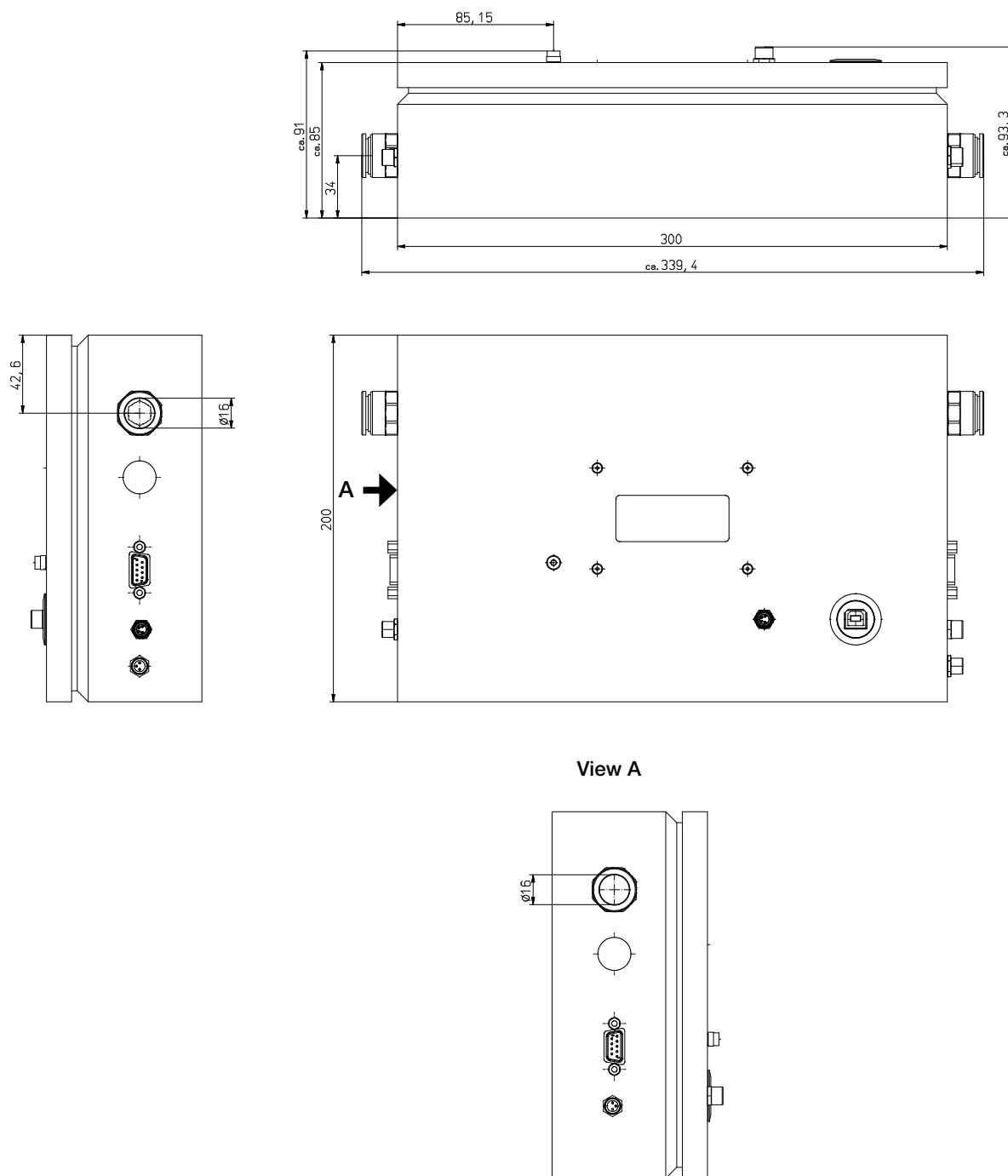

All dimensions in mm (general tolerance ISO 2768-v)

16.4 Dimensions PLM 40

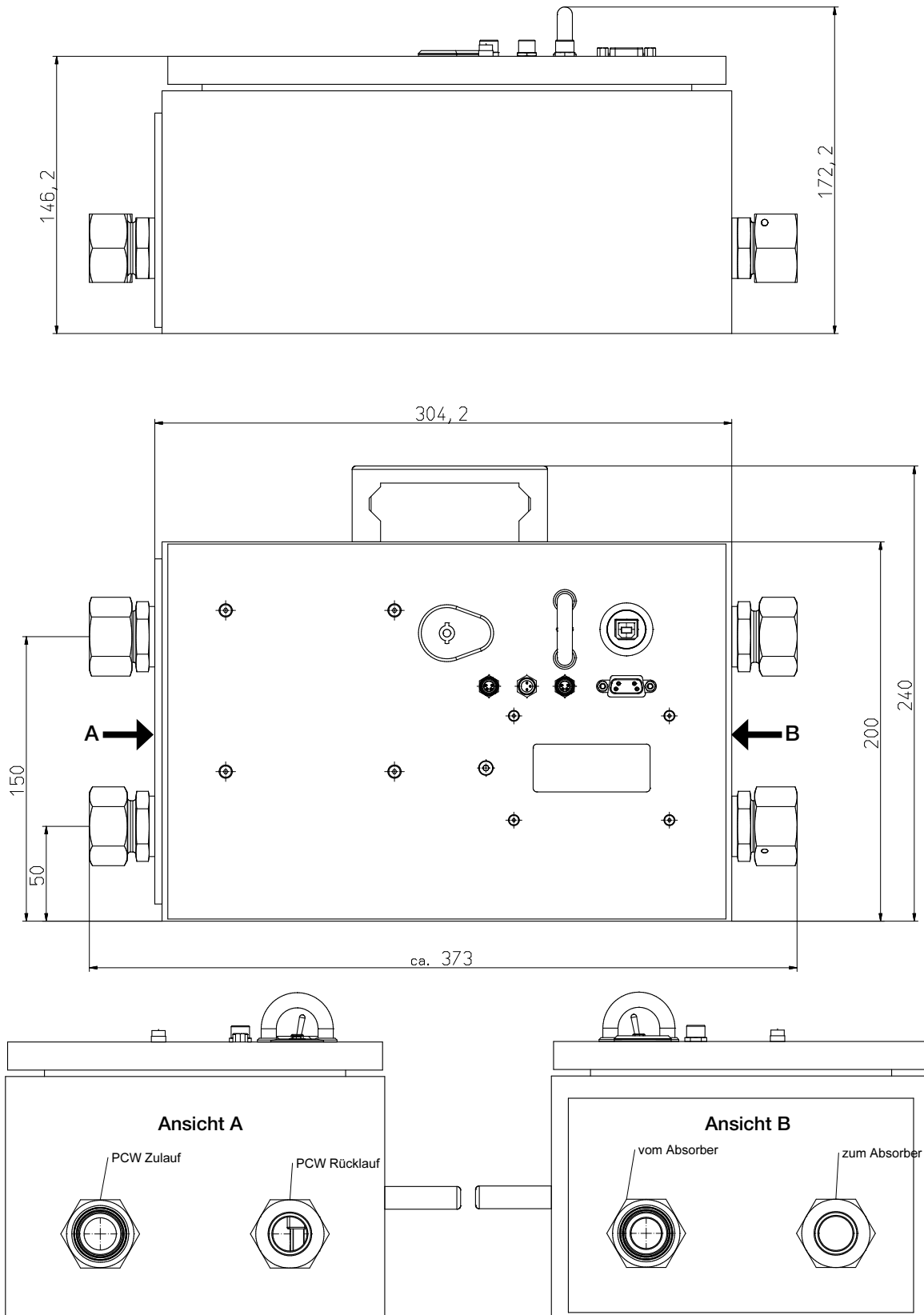

All dimensions in mm (general tolerance ISO 2768-v)