

## Original Instructions



## Cube M

Cube M A with advanced absorber

LaserDiagnosticsSoftware LDS

Cube App



**IMPORTANT!**  
**READ CAREFULLY BEFORE USE.**  
**KEEP FOR FUTURE USE.**

## Table of contents

1	Basic safety notes	8
2	Icons and conventions	10
3	About this operating manual	12
4	Device description	13
4.1	Functional description	13
4.2	Measuring principle	13
4.3	Functions of the On/Off button	14
4.4	Optical display	14
4.4.1	Status messages	14
4.4.2	Warning message	15
4.5	Scope of delivery and optional accessories	15
4.6	Important notes on the lithium-ion battery	15
4.6.1	Charging the lithium-ion battery	16
4.6.2	Storing the device with a permanently installed lithium-ion battery	16
4.6.3	Dangers to health and the environment in the event of damage to the lithium-ion battery	16
4.6.4	Charge status of the lithium-ion battery	16
5	Transport and storage	17
5.1	Warning messages	17
5.2	Shipping the device with permanently installed battery	17
6	Install LaserDiagnosticsSoftware LDS	18
7	Mounting	19
7.1	Conditions at the installation site	19
7.2	Installation in the laser system	19
7.2.1	Prepare mounting	19

7.2.2	Possible mounting positions .....	19
7.2.3	Align the device.....	19
7.2.4	Align the device centrally using the alignment tool .....	22
7.2.5	Mount the device.....	23
7.3	Removal from the laser system .....	24
<b>8</b>	<b>Connections</b> .....	<b>25</b>
8.1	Overview of connections.....	25
8.2	Micro-USB port.....	25
8.2.1	PRIMES USB driver.....	25
8.2.2	Install the USB driver manually .....	26
8.3	Bluetooth® .....	27
8.3.1	Recommended Bluetooth® dongle and Bluetooth® specifications .....	27
8.3.2	Activate Bluetooth® on the PC (Windows® 10) .....	27
8.3.3	Connect device to PC via Bluetooth® (Windows® 10) .....	27
8.4	Safety interlock .....	28
<b>9</b>	<b>Laser parameter setting</b> .....	<b>30</b>
9.1	Setting the laser rise time.....	30
9.2	Maximum permissible power density.....	31
9.3	Minimum and maximum energy input per measurement .....	32
9.4	Waiting times until the next measurement in serial measurements.....	33
9.5	Measurement with pulsed lasers .....	34
<b>10</b>	<b>Measure</b> .....	<b>35</b>
10.1	Warning messages .....	35
10.2	Measuring with the Cube M .....	37
10.2.1	Start measurement.....	37
10.2.2	Display of measurement results .....	39
10.3	Measuring with the optional LaserDiagnosticsSoftware LDS .....	40

10.3.1	Connect/disconnect the device with the LDS .....	40
10.3.2	Open toolbench Cube Measurement.....	42
10.3.3	Settings in the device control.....	43
10.3.4	Start measurement.....	46
10.3.5	Measuring results display .....	47
10.3.6	Delete measurements from the memory of the Cube M.....	52
10.4	Measuring with the optional Cube App.....	52
<b>11</b>	<b>Troubleshooting</b>	<b>53</b>
11.1	Messages in the LaserDiagnosticsSoftware LDS during measurement .	53
11.2	Connection failure with the LDS .....	55
11.3	Other errors .....	55
<b>12</b>	<b>Maintenance and service</b>	<b>58</b>
12.1	Maintenance intervals .....	58
12.2	Cleaning .....	58
12.2.1	Cleaning the device surface.....	58
12.2.2	Cleaning the protective window.....	58
12.3	Exchanging the protective window on the device.....	59
12.3.1	Warning messages.....	60
12.3.2	Exchanging the protective window .....	61
<b>13</b>	<b>Measures for the product disposal</b>	<b>62</b>
<b>14</b>	<b>Declaration of conformity</b>	<b>63</b>
<b>15</b>	<b>Technical data</b>	<b>65</b>
<b>16</b>	<b>Dimensions</b>	<b>67</b>
<b>17</b>	<b>Appendix</b>	<b>69</b>
A	GNU GPL license notice .....	69

## PRIMES - the company

PRIMES is a manufacturer of measuring devices which are used to analyze laser beams. These devices are employed for the diagnostics of high-power lasers ranging from CO<sub>2</sub>-, fiber- and solid-state lasers to diode lasers. A wavelength range from infrared through to near UV is covered, offering a wide variety of measuring devices to determine the following beam parameters:

- Laser power
- Beam dimensions and position of an unfocused beam
- Beam dimensions and position of a focused beam
- Beam quality factor  $M^2$

Development, production and calibration of the measuring devices is performed at PRIMES. This guarantees optimum quality, excellent service, and a short reaction time, providing the basis for us to meet all of our customers' requirements quickly and reliably.



PRIMES GmbH  
Max-Planck-Str. 2  
64319 Pfungstadt  
Germany

Tel +49 6157 9878-0  
info@primes.de  
www.primes.de

## 1 Basic safety notes

### **Intended use**

The device has been designed exclusively for measurements in the beam of high-power lasers.

Use for any other purpose is considered as not intended and is strictly prohibited. Furthermore, intended use requires that you observe all information, instructions, safety notes and warning messages in this operating manual. The specifications given in chapter 15 „Technical data“ on page 65 apply. Any given limit values must be complied with.

If not used as intended, the device or the system in which the device is installed can be damaged or destroyed. In addition, there is an increased risk to health and life. Only use the device in such a way that there is no risk of injury.

This operating manual is an integral part of the device and must be kept in the immediate vicinity of the place of use, accessible to personnel at all times.

Every person who is responsible for the installation, start-up or operation of the device must have read and understood the operating manual and, in particular, the safety instructions.

If you still have questions after reading this operating manual, please contact PRIMES or your supplier for your own safety.

### **Observing applicable safety regulations**

Observe the safety-relevant laws, guidelines, standards and regulations in the current editions published by the state, standardization organizations, professional associations, etc. In particular, observe the regulations on laser safety and comply with their requirements.

### **Necessary safety measures**

The device measures direct laser radiation, but does not emit any radiation itself. However, during the measurement the laser beam is directed at the device. This produces scattered or directed reflection of the laser beam (laser class 4). The reflected beam is usually not visible.



Protect yourself from direct and reflected laser radiation while working with the device by taking the following measures:

- Never leave the device unattended when taking measurements.
- Wear **safety goggles** adapted to the power, power density, laser wavelength and operating mode of the laser beam source in use.
- Wear suitable **protective clothing** or **protective gloves** if necessary.
- If possible, also protect yourself from direct laser radiation and scattered radiation by using separating protective devices that block or attenuate the radiation.
- If the device is moved from its aligned position, increased scattered or directed reflection of the laser beam occurs during measuring operation. Mount the device in such a way that it cannot be moved unintentionally, i.e. by bumping or pulling the cables
- Connect the laser control's safety interlock to the device. Check that the safety interlock will switch off the laser properly in case of error.
- Install safety switches or emergency safety mechanisms that allow the laser to be switched off immediately.
- Use suitable beam guidance and beam absorber elements which do not emit any hazardous substances when irradiated.

### **Employing qualified personnel**

The device may only be operated by qualified personnel. The qualified personnel must have been instructed in the installation and operation of the device and must have a basic understanding of working with high-power lasers, beam guiding systems and focusing units.

### **Conversions and modifications**

The device may not be modified in terms of design or safety without the explicit consent of the manufacturer. The same applies to unauthorized opening, dismantling and repair. The removal of covers is only permitted within the scope of the intended use.

### **Liability disclaimer**

Manufacturer and distributor exclude any liability for damages and injuries which are direct or indirect consequences of using the device not as intended or modifying the device or the associated software without authorization.

## 2 Icons and conventions

### Warning messages

The following icons and signal words indicate possible residual risks in the form of warnings:



#### **DANGER**

Means that death or serious physical injuries **will** occur if necessary safety precautions are not taken.



#### **WARNING**

Means that death or serious physical injuries **can** occur if necessary safety precautions are not taken.



#### **CAUTION**

Means that a slight physical injury **can** occur if necessary safety precautions are not taken.

#### **NOTICE**

Means that property damages **can** occur if necessary safety precautions are not taken.

### Product safety labels

The following icons are used on the device itself to indicate imperatives and possible dangers:



Read and understand the operating manual before using the device!





Labeling according to WEEE directive:

The device must not be disposed of with household waste, but in a separate WEEE collection in an environmentally friendly way.

## Further icons and conventions in this operating manual



Here you will find useful information and helpful tips.

- ▶ Indicates a single instruction.  
If several of these instructions appear one below the other, the order in which they are executed is irrelevant or they represent alternative courses of action.
- 1. A numbered list identifies a sequence of instructions that must be executed in the specified order.
- 2.
- ...
- ➔ Indicates the result of an action to explain processes that take place in the background.
- 👁 Indicates an observation prompt to draw attention to visible feedback from the device or the software.  
Observation prompts make it easier to check whether an instruction was executed successfully. Often they also guide to the next instruction.
-  Points to a control element that is to be pressed/clicked.
-  Points to an element described in the text (for example an input field).

### 3 About this operating manual



This operating manual describes the Cube M with advanced absorber. Devices with an advanced absorbers are marked with **Cube M A** on the identification plate.

Devices with a standard absorbers are marked with **Cube M** on the identification plate. For an earlier version of the operating manual with standard absorber, contact us by e-mail: ***support@primes.de***

This manual describes the installation and operation of the Cube M A and performing measurements with the Cube M A, the optional Cube App or the optional LaserDiagnosticsSoftware LDS version 1.4 or higher. In this operating manual, the abbreviations Cube M and LDS are used.

With the Cube App for mobile devices with Android™ you can operate and evaluate the device via a smartphone/tablet. The Cube App is available for free in Google Play-Store/ Apps.

For measurement operation with a PC, the optional LaserDiagnosticsSoftware LDS must be installed on the PC. PRIMES will be happy to provide you with a current download link. For this purpose, contact your sales partner or send an e-mail to:

***support@primes.de***

The software description includes a brief introduction on using the device for measurements. For a detailed description of the software installation, file management and evaluation of the measurement data, please refer to the separate instructions for the LaserDiagnosticsSoftware LDS.



This operating manual describes the software version valid at the time of printing. Since the LDS is subject to continuous development, the supplied data medium may have a newer version number.

## 4 Device description

### 4.1 Functional description

The device is used to measure laser power. The laser beam passes through the protective window and hits the absorber and a photodiode. The absorber and the photodiode are protected from contamination by the protective window. The display shows the measured laser power and further information on the status of the device.

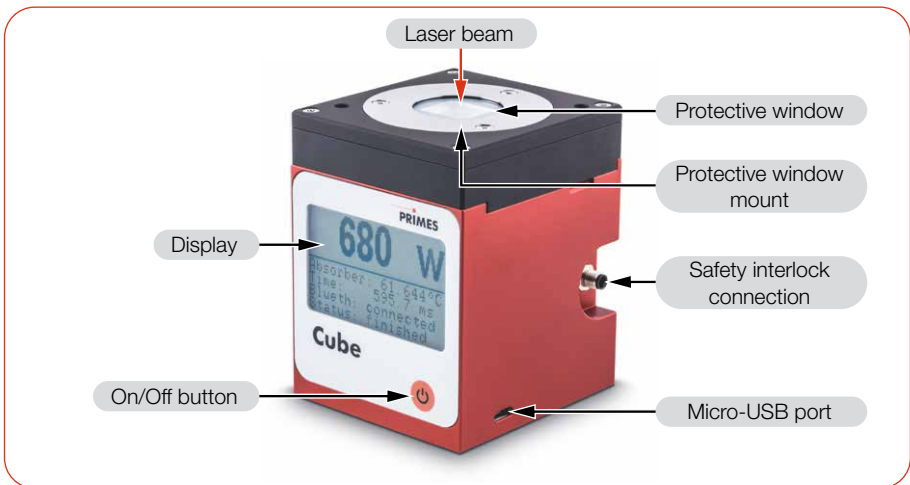

Fig. 4.1: Functional description

### 4.2 Measuring principle

The device offers a fast, passively cooled power measurement according to the calorimetric measuring principle.

The absorber of the measuring device is briefly irradiated with the laser beam. The irradiated energy is determined by the temperature rise of the absorber.

The photodiode simultaneously determines the laser ontime. The high-frequency sampling rate of the photodiode enables single pulse detection for pulses not shorter than 50  $\mu\text{s}$ .

Thus, in addition to the average power, the peak power can be calculated. In the second step, the actual laser power is calculated from the irradiated energy divided by the laser ontime.

## 4.3 Functions of the On/Off button

The On/Off button has several functions:

Keystroke	Function	
	Short press	Switch on
	5 seconds	Switch off
	2 seconds	Show measuring values
	Press again for 2 seconds	Switch to next window

Tab. 4.1: Functions of the On/Off button

## 4.4 Optical display

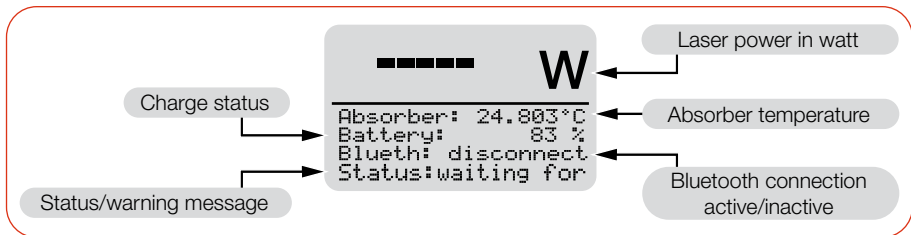

Fig. 4.2: Optical display

### 4.4.1 Status messages

Status message	Meaning
Waiting for laser beam	The device is ready for operation, the laser can be switched on.
Check temp.	The temperature gradient (change in the absorber temperature/time) is checked. Please wait until the message disappears.
Thermalize	The thermalization time allows a uniform temperature distribution in the absorber. Afterwards, the temperature is measured.
Finished	The measurement is completed.

Tab. 4.2: Status messages

#### 4.4.2 Warning message

Warning message	Reason
Safety interlock open	The absorber temperature has exceeded 100 °C. In order to protect the device, the safety interlock was triggered.

Tab. 4.3: Warning message



This warning message does not imply an error. The message is automatically reset as soon as the absorber temperature is below 100 °C again. The safety interlock is then also automatically switched back to the permissible operating status.

Detailed information on triggering the safety interlock is described in chapter 8.4 on page 28.

#### 4.5 Scope of delivery and optional accessories

The following parts are within the scope of delivery:

- Cube M
- Alignment tool
- Cable USB 2.0, 1.8 m
- Safety interlock cable with one-sided connector M5, 2 m (Co. Binder, order number: 77 3450 0000 40003-0200)
- Operating manual or quick start guide Cube M
- Transport and storage bag

The following accessories are available:

- LaserDiagnosticsSoftware LDS
- Cube App

#### 4.6 Important notes on the lithium-ion battery

The device is equipped with a permanently installed rechargeable battery. Be aware that this battery may ignite at high temperatures. For operation, storage and shipping, refer to the information according to chapter 15 „Technical data“ on page 65.

#### **4.6.1 Charging the lithium-ion battery**

Charge the battery completely before using the device for the first time. The first complete charge on the PC requires approx. 3 hours. Only use the supplied USB cable to charge the battery. Recharge the battery when the charge level reaches 20 %. Do not charge the rechargeable battery unattended, e.g. overnight. Do not expose the device to direct sunlight.

#### **4.6.2 Storing the device with a permanently installed lithium-ion battery**

Store the device in a cool, dry place. Keep a minimum distance of 3 m from combustible materials. Do not expose the device to direct sunlight. Please charge the battery at least every three months.

#### **4.6.3 Dangers to health and the environment in the event of damage to the lithium-ion battery**

In general, contact with leaking battery components may pose a hazard to health and the environment:

- When the battery is damaged, fluids (electrolytes) may leak out. These are flammable, contact with the eyes or skin may cause irritation.
- Vapors may irritate the eyes, respiratory organs, and skin.
- Fire or intense heat may cause violent bursting. Heating or fire may release toxic gases. Burning produces irritating smoke.

#### **4.6.4 Charge status of the lithium-ion battery**

The charge status of the battery is displayed in %. The accuracy of the display depends on various factors (e.g. temperature, age of the battery, etc.).

The battery has a capacity of 1 000 mAh. The battery can be charged with a max. charging current of 1.3 A via the supplied USB cable. At a charging current of 1.0 A, the charging time is approx. 1 hour. At a charging current of 0.5 A, the charging time is approx. 2.5 hours.

At 100 % charge status, the possible operating time is approx. 6 hours (equivalent to approx. 100 measurements). When using all power saving functions (see section „Power saving functions“ in chapter 10.3.3 „Settings in the device control“ on page 43) approx. 15 hours.



## 5 Transport and storage

### 5.1 Warning messages

#### **NOTICE**

##### **Damaging/Destruction of the device**

Hard impacts can damage the absorber within the device.

- ▶ Handle the device carefully when transporting or installing it.
- ▶ To avoid contamination, cover the inlet aperture with the alignment tool provided.

### 5.2 Shipping the device with permanently installed battery

The device is equipped with a permanently installed lithium-ion battery (hereinafter referred to as battery). A removal of the battery by the end user is not intended for this product.

In case of shipment the device is a dangerous good. Due to the permanently built-in battery it is classified as "lithium ion batteries contained in equipment".

- ▶ Please observe the requirements for shipping according to the valid regulations.

#### **Particularly in case of a damaged battery, special regulations must be observed:**

A damaged battery can cause fire! These batteries must be sorted out, checked and, if necessary, repacked by qualified personal!

- ▶ If you need more information on how to safely remove the battery, please contact us at: ***support@primes.de***

#### **Battery details for shipping:**

Cell/battery typ: Lithium Ion

Cell or battery: Battery

LC or Wh rating: 3.7 Wh

Cell/battery weight: 20 g

UN-Classification: UN 3481: Lithium ion batteries contained in equipment

## 6 Install LaserDiagnosticsSoftware LDS



For measurement operation with a PC, the optional LaserDiagnosticsSoftware LDS must be installed on the PC. PRIMES will be happy to provide you with a link to download the current version. Please contact your sales partner or contact us by e-mail: **support@primes.de**

1. Please ensure:
  - System requirements are met.
  - You have administrator rights.
2. Close all programs on your PC.
3. Download the LDS via the download link.

### System requirements:

- Intel Pentium Core i3 or better
- Windows 10 (64-bit version)
- At least 4 GB RAM; 8 GB RAM recommended
- Display resolution: Full HD (1 920 x 1 080) at 100 % scaling
- A USB port or Bluetooth for connecting the measuring device

4. Double-click the LDS\_Setup.exe file to start the installation.
  5. Follow the instructions on the screen.
- ➔ If no other location is specified, then the main program **LDS.exe** will be copied to the directory **C:\Programs\Primes\Laser-DiagnosticsSoftware**.

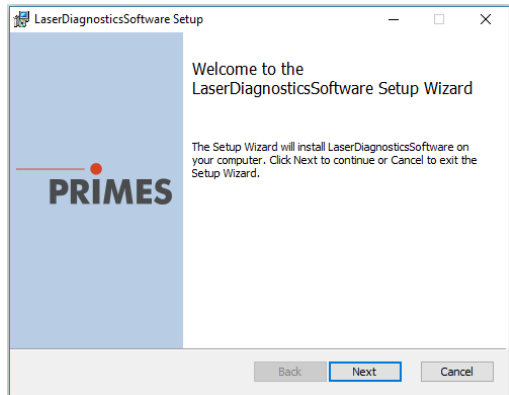

## 7 Mounting

### 7.1 Conditions at the installation site

- The device must not be operated in a condensing atmosphere.
- The ambient air must be free of gases and aerosols that interfere with the laser radiation (e.g. organic solvents, cigarette smoke, sulfur hexafluoride).
- Protect the device from splashes of water and dust.
- Operate the device in closed rooms only.

### 7.2 Installation in the laser system

#### 7.2.1 Prepare mounting

1. Switch off the laser beam.
2. Ensure that moving parts, e.g. robot arms, etc. are at a standstill and that they cannot be set in motion unintentionally.

#### 7.2.2 Possible mounting positions

The device can be mounted vertically or horizontally.

#### 7.2.3 Align the device

The device must be aligned to the laser beam. The laser beam must hit the centre of the inlet aperture. Please mind and adhere to the specifications and limit values given in chapter 15 „Technical data“ on page 65.

An alignment tool is supplied for centering the device under the laser (see chapter 7.2.4 on page 22).

## Use of the device with the focal plane on the bottom edge of the device

The focal plane of the laser beam should be on the bottom edge of the device. The laser beam should be convergent (see Fig. 7.1 on page 20).

## Use of the device with the focal plane above the bottom edge of the device

Alternatively, the device can be used with the focal plane above the bottom edge of the device. The beam entrance of the device can be located in the convergent or divergent range of the laser beam (see Fig. 7.2 on page 21).

### Please observe:

- the beam diameter of 1 – 4 mm at the beam entrance
- the max. permissible power density of 250 kW/cm<sup>2</sup> at the beam entrance
- the max. tolerance to the centered beam incidence of  $\pm 2.0$  mm
- the max. permissible beam divergence of 300 mrad (full angle) with perpendicular beam incidence

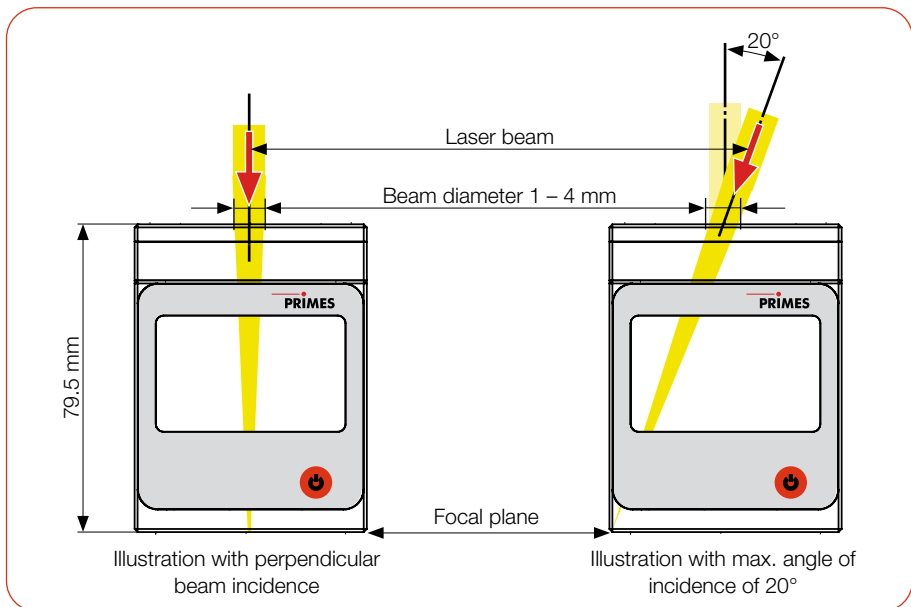

Fig. 7.1: Alignment to the laser beam with the focal plane on the bottom edge of the device

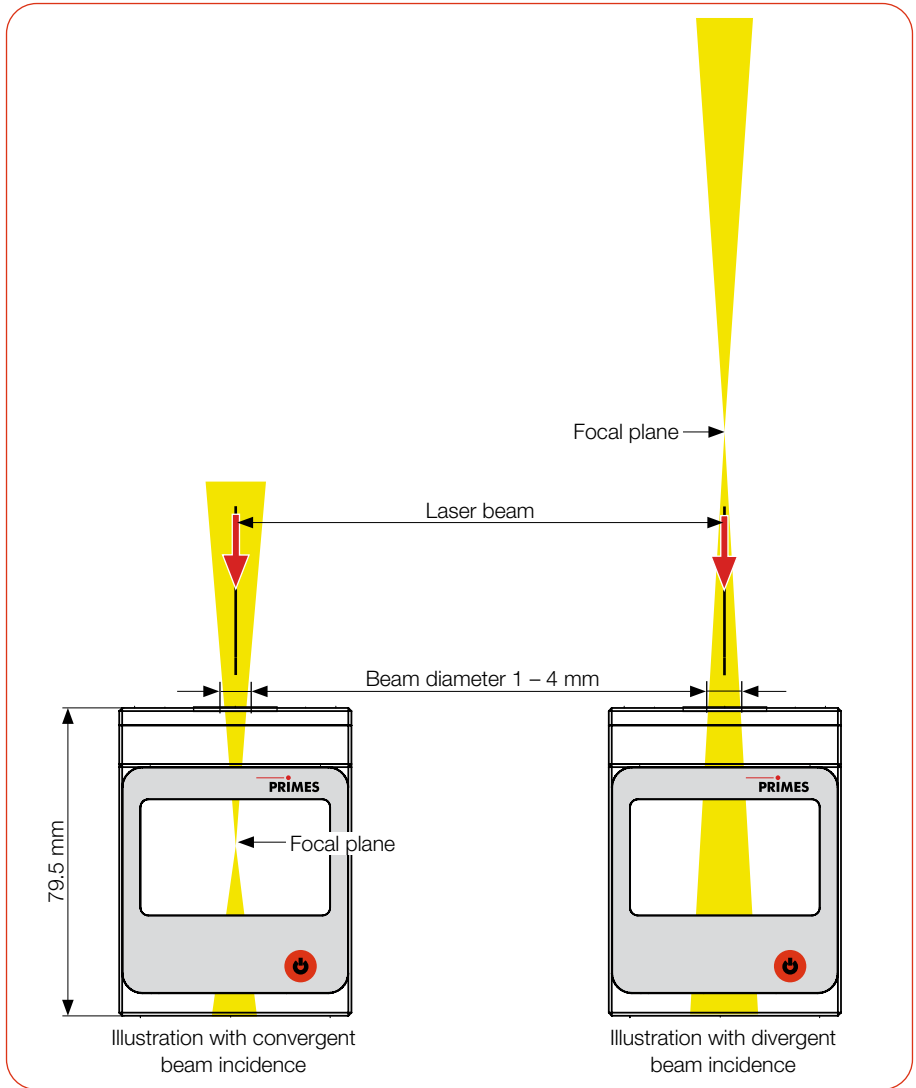

Fig. 7.2: Alignment to the laser beam with the focal plane above the bottom edge of the device

## 7.2.4 Align the device centrally using the alignment tool

The alignment tool is within the scope of delivery. It can be reordered under order number 410-011-043.

Using the alignment tool and a pilot laser beam, you can position the device with the necessary accuracy (see Fig. 7.3 on page 22).

1. Put the alignment tool on the inlet aperture.
2. Switch on the pilot laser and align the device. If the laser beam hits the little marking in the alignment tool, the device is aligned.

### NOTICE

#### Damaging/Destruction of the device

The alignment tool will be destroyed by laser radiation.

- ▶ Remove the alignment tool before switching on the laser.

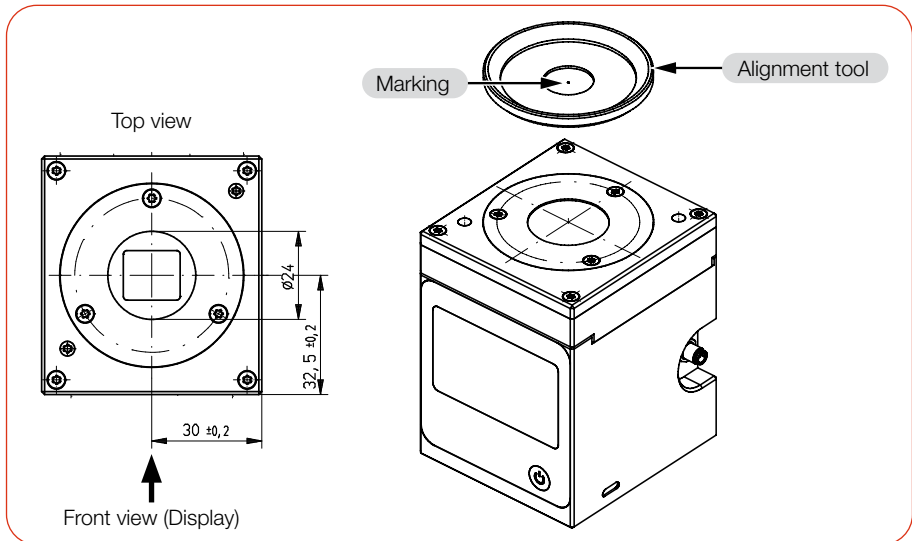

Fig. 7.3: Alignment of the device using the alignment tool (dimensions in mm)

### 7.2.5 Mount the device



#### **DANGER**

##### **Serious eye or skin injury due to laser radiation**

If the device is moved from its aligned position, increased scattered or directed reflection of the laser beam can occur during measuring operation (laser class 4).

- ▶ Mount the device in such a way that it cannot be moved by an unintended push or a pull on the cables.

#### **NOTICE**

##### **Damaging/Destruction of the device**

Contamination and fingerprints on the protective window can cause damage or cracking respectively splintering of the protective window during measuring operation.

- ▶ Do not touch the protective window with bare hands.
- ▶ Regularly check the condition of the protective window. The protective window can be cleaned or replaced in case of heavy, non-removable contamination (see chapter 12 „Maintenance and service“ on page 58).
- ▶ Only operate the device with a clean protective window.

1. Mount the device on the mounting threads according to Fig. 7.4 on page 24. The total length of the screws depends on the dimensions of the customer's bracket.
2. Ensure a stable installation of the device. The device must not be able to move.
3. If a safety circuit is provided, connect the safety interlock connection cable.

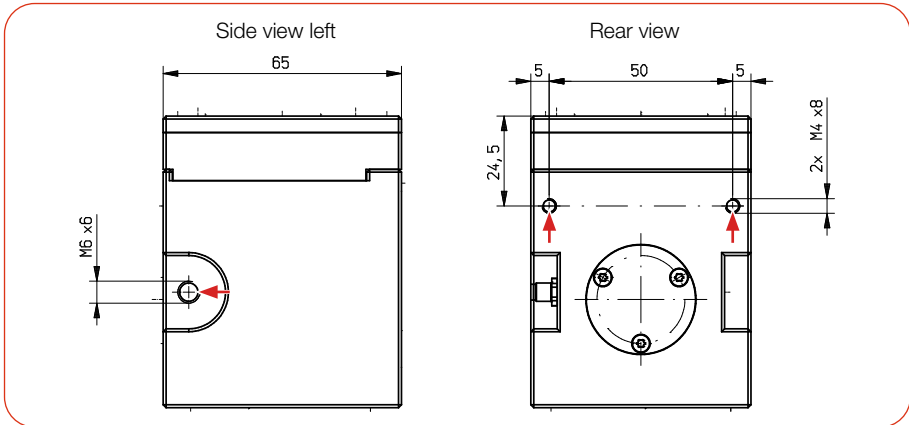

Fig. 7.4: Mounting threads in the housing (dimensions in mm)

### 7.3 Removal from the laser system

1. Switch off the laser beam.
2. Ensure that moving parts, e.g. robot arms, etc. are at a standstill and that they cannot be set in motion unintentionally.
3. Unscrew the mounting screws (see Fig. 7.4 on page 24).
4. Disconnect electrical connections.
5. Remove the device from the laser system.
6. To avoid contamination, close the inlet aperture using the alignment tool supplied.



## 8 Connections

### 8.1 Overview of connections



Fig. 8.1: Overview of connections

### 8.2 Micro-USB port

You can charge the battery of the device on the PC via the micro USB port. Only use the supplied USB cable to charge the battery.

When using the optional LaserDiagnosticsSoftware LDS (not within delivery), the device communicates with the LDS via the micro-USB port or Bluetooth®.



Note that a USB interface without additional interference suppression measures is not EMC-compliant. Therefore, in industrial environments with strong sources of interference, connection interruptions and data transmission disturbances may occur.

#### 8.2.1 PRIMES USB driver

You will find the PRIMES USB driver for all USB-capable devices on the PRIMES website at: <https://www.primes.de/en/support/downloads/software.html>

## 8.2.2 Install the USB driver manually

The driver installation requires administrator rights.

1. Download the USB driver from the PRIMES website.
2. Save the driver to a data carrier.
3. Connect the data carrier to a PC.
4. Double-click to start the driver installation software.
5. Follow the instructions on the screen.

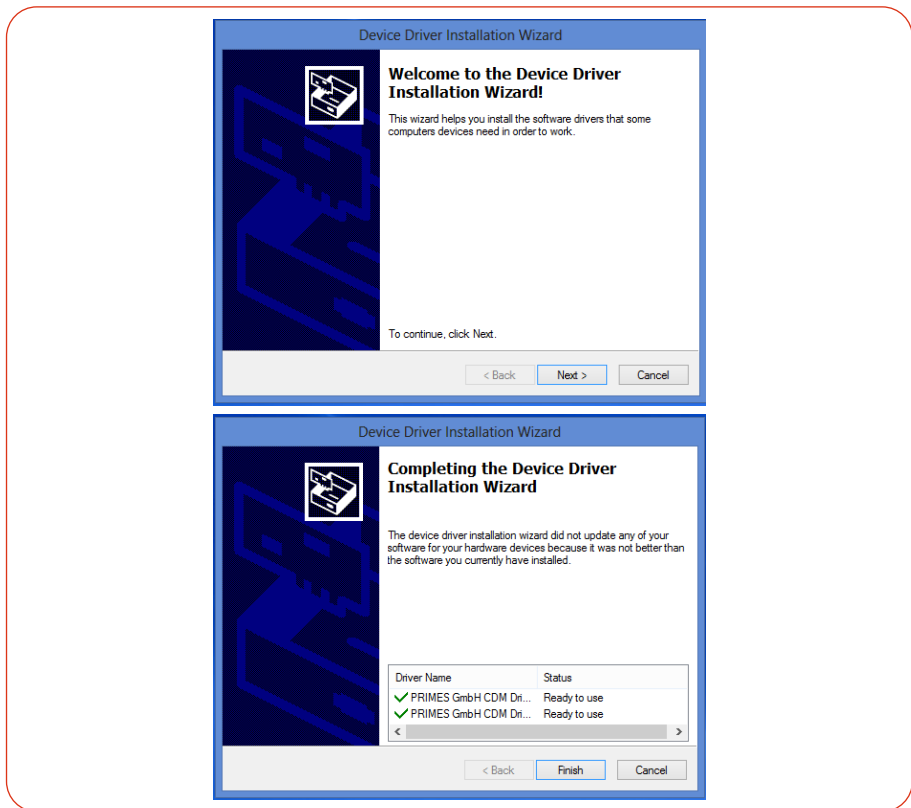

Fig. 8.2: Windows® menu for USB driver installation

6. Click **Finish** to complete the installation.

## 8.3 Bluetooth®

A class 1 Bluetooth® interface is integrated in the device. This enables a wireless connection with the PC, tablet or smartphone. When connected to a PC with a class 1 Bluetooth® dongle, the range under free space conditions is approx. 100 m. After switching on the device, the Bluetooth® connection is permanently active. When the Bluetooth® connection is activated, the USB interface is deactivated. However, simultaneous charging of the battery via the USB cable is possible. When using the optional Cube App for mobile devices with Android™ (not within the scope of delivery), the device communicates with the app via Bluetooth®. The Cube App is available for free in Google Play-Store/Apps.

### 8.3.1 Recommended Bluetooth® dongle and Bluetooth® specifications

#### Recommended Bluetooth® dongle

LOGILINK BT0037 Bluetooth 4.0 Micro USB Dongle (Class 1)

#### Bluetooth® specifications

Bluetooth® version: 2.1+EDR

Transmission power: Class 1 (<= 20 dBm)

Bluetooth® Profile: Generic Access Profile (GAP), Serial Port Profile (SPP)

### 8.3.2 Activate Bluetooth® on the PC (Windows® 10)

1. Open the Bluetooth® menu via **Start > Settings > Devices**.
2. Check under **Bluetooth- and devices** if your PC supports Bluetooth®.
- 👁️ If Bluetooth® is supported, a **Bluetooth** button is displayed.
3. Set the **Bluetooth** switch to the **ON** position.

### 8.3.3 Connect device to PC via Bluetooth® (Windows® 10)

1. Press the On/Off button  on the Cube M.
2. Open the Bluetooth® menu via **Start > Settings > Devices**.
3. Click the **+ sign**.
4. Under **Add Device**, click **Bluetooth**.
- 👁️ The Cube M is displayed with its serial number (see identification plate).
5. Click the Cube M.  
Confirm the prompt to pair the Cube M.
- ➔ The Cube M will be connected.
6. Connect the Cube M to the LDS according to chapter 10.3.1 on page 40.

## 8.4 Safety interlock

### NOTICE

#### Damaging/Destruction of the device

If the safety interlock is not connected, the device can be damaged or destroyed due to overheating.

- ▶ Connect the safety interlock to the device.

The use of the safety interlock protects the device from damage in many situations. Nevertheless, depending on the parameters of the laser beam to be measured, damage to the absorber may occur. Please observe the specifications and limit values given in chapter 15 „Technical data“ on page 65.

During irradiation, the temperature of the absorber can rise significantly above 100 °C for a short time because the heat has not yet been distributed evenly in the absorber. To avoid triggering the safety interlock during irradiation in this case, the safety interlock is only triggered at a temperature above 200 °C when irradiation is in progress.

Therefore, when a running irradiation is detected, the interlock threshold is temporarily increased from 100 °C to 200 °C. After the end of the irradiation, the interlock threshold is reduced again to 100 °C.

If the temperature of the absorber is above 100 °C after the measurement is completed, the safety interlock is triggered to protect the absorber. This prevents the device from being irradiated again.

Pin 3 and pin 4 are connected when a safety interlock is triggered. After the absorber has cooled down, pin 1 and pin 4 of the safety interlock are connected. Please observe the information on minimum and maximum energy input per measurement according to chapter 9.3 on page 32.

A suitable safety interlock cable with one-sided connector M5, 2 m (Co. Binder, order number: 77 3450 0000 40003-0200) is within the scope of delivery.

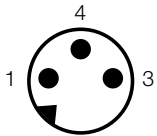
Safety interlock connection (view connection on device)			
	Pin	Wirecolor	Function
	4	Black	Common pin
	1	Brown	Connected with pin 4, when ready for operation
	3	Blue	Connected with pin 4, when in safety interlock mode (absorber too hot)

Tab. 8.1: Pin assignment of safety interlock connection and wire colors of connection cable

## 9 Laser parameter setting

For correct measurements and to protect the device from damage, the following parameters must be observed and adhered to.

### 9.1 Setting the laser rise time

The applicable irradiation time is between 0.1 s and 2.0 s, which has to be transferred to the laser controller as pulse duration/burst duration. The maximum laser rise time for power measurement must not exceed 1 % of the irradiation time. This limit has to be adhered to in order to avoid incorrect results of the power measurement.

Some laser beam sources are factory set with power ramps of up to a few 100 ms to switch on the laser beam. To achieve a high measuring accuracy the shortest possible rise time has to be set.

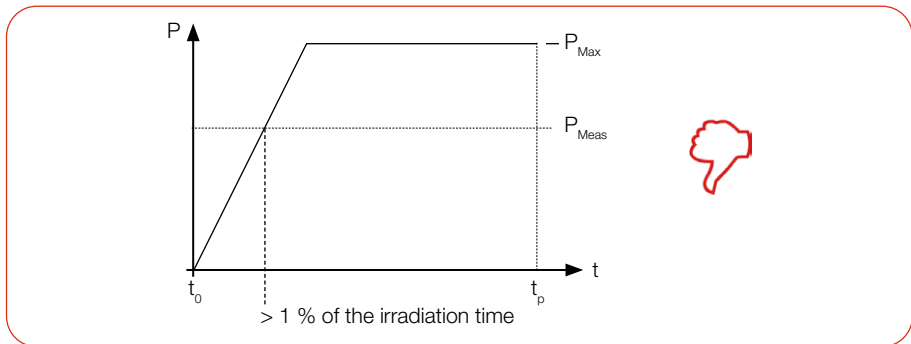

Fig. 9.1: Laser rise time  $> 1\%$  of the irradiation time

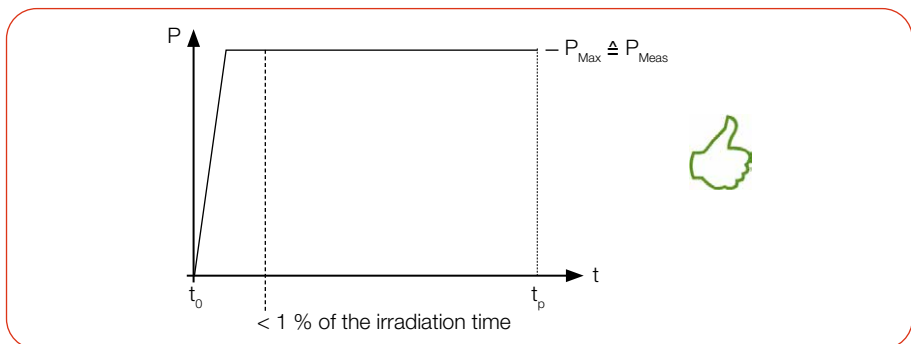

Fig. 9.2: Laser rise time  $< 1\%$  of the irradiation time

## 9.2 Maximum permissible power density

To avoid damage, the maximum permissible power density of 250 kW/cm<sup>2</sup> must not be exceeded at the optics.

The power density in kW/cm<sup>2</sup> is calculated according to the formula:

$$Power\ density = \frac{P_{Laser\ power\ in\ kW}}{\pi \cdot r^2_{Beam\ radius\ in\ cm}}$$

Formula 1: Calculation of the power density

To determine the maximum laser power, the result is weighted with a safety factor of 2. The safety factor compensates the ratio of maximum to average power density of a Gaussian beam (far field). The maximum permissible laser power in kW depending on the beam radius is calculated according to the formula:

$$P_{Laser\ power\ in\ kW} = max.\ Power\ density \frac{kW}{cm^2} \cdot \pi \cdot r^2_{Beam\ radius\ in\ cm} \cdot \frac{1}{2}$$

Formula 2: Calculation of the permissible laser power depending on the beam radius

The minimum permissible beam radius in cm depending on the permissible power density and laser power is calculated according to the formula:

$$r_{Beam\ radius\ in\ cm} = \sqrt{\frac{P_{Laser\ power\ in\ kW}}{max.\ Power\ density \frac{kW}{cm^2} \cdot \pi \cdot \frac{1}{2}}}$$

Formula 3: Calculation of the minimum permissible beam radius depending on the permissible power density and the laser power

Example: With the maximum permissible power density of 250 kW/cm<sup>2</sup> at the optics and a laser power of 2 kW, the minimum permissible beam radius is calculated as follows:

$$r_{Beam\ radius\ in\ cm} = \sqrt{\frac{2\ kW}{250 \frac{kW}{cm^2} \cdot \pi \cdot \frac{1}{2}}} = 0,071\ cm = 0,71\ mm$$

Formula 4: Example calculation

### 9.3 Minimum and maximum energy input per measurement

The measured temperature rise in the absorber is decisive for an accurate and reproducible measurement. Regardless of the starting temperature, we recommend an energy input of approx. 300 J per measurement.

Example: At 1 kW laser power the recommended pulse duration is 300 ms.

$$E = P \cdot t = 1\,000\text{ W} \cdot 0.3\text{ s} = 300\text{ J}$$

Fig. 9.3 on page 32 shows the permissible energy input for a measurement as a function of the absorber temperature.

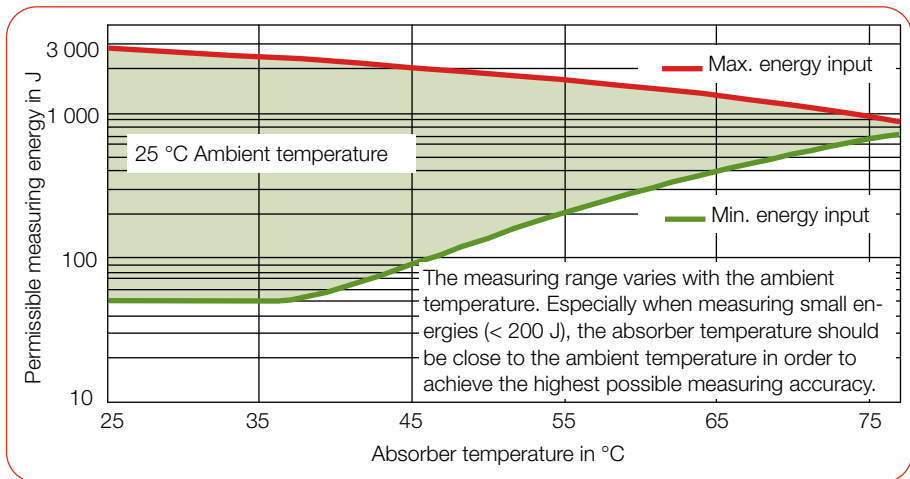

Fig. 9.3: Measuring range as a function of the absorber temperature

The minimum energy input indicates the lower limit values with which measurements can still be performed within the specified accuracy. The maximum energy application value specifies the limit at which the absorber reaches its permissible limit temperature. The energy, e.g. for multiple measurements (serial measurements) can be distributed across the range shown in green.

If the absorber temperature is higher than 70 °C, no further measurement should be performed. In this case, please wait until the absorber temperature has fallen below 50 °C (depending on the selected energy input). Please take the limit values from Fig. 9.3 on page 32 and Tab. 9.1 on page 33.



Absorber temperature in °C	Min. energy input in J	Max. energy input in J
20	50	3 000
25	50	2 800
30	50	2 600
35	50	2 400
40	60	2 200
45	90	2 100
50	140	1 900
55	200	1 700
60	290	1 500
65	390	1 300
70	520	1 100

Tab. 9.1: Absorber temperature with the recommended minimum and permissible maximum energy input (ambient temperature 20 °C)

#### 9.4 Waiting times until the next measurement in serial measurements

Please note that at high measuring frequencies the measuring accuracy may be limited. For serial measurements within the specified accuracy, the following waiting times are recommended before the next measurement.

Energy input in J	Waiting time in s
200	50
400	100
600	150
800	200
1 000	250

Tab. 9.2: Waiting times until the next measurement in serial measurements

### 9.5 Measurement with pulsed lasers

When using pulsed laser radiation a correct exposure time measurement is possible up to a pulse frequency of 10 kHz and a duty cycle of 50 %. In case of ontimes/offtimes shorter than 50  $\mu$ s a correct exposure time measurement is not possible.

With pulsed lasers, the device recognizes the number of pulses  $n$  and the number of pulse pauses  $n-1$ . The last pulse pause  $t_{off}$  is not measured for physical reasons. This leads to an increased display of the average power with a low number of pulses. The average power is corrected on the basis of the corrected burst duration (see Fig. 9.4 on page 34).

For cw lasers and lasers with one pulse, the average power corresponds to the maximum power of one pulse.

When measuring pulsed lasers, the technical specification according to chapter 15 „Technical data“ on page 65 must be observed.

Measurements outside the specification may result in an incorrect calculation of the number of pulses (pulses). This affects the calculated max. power of a pulse (Pk Pow). But not on the calculated average laser power (Av Pow) and energy (Energy).

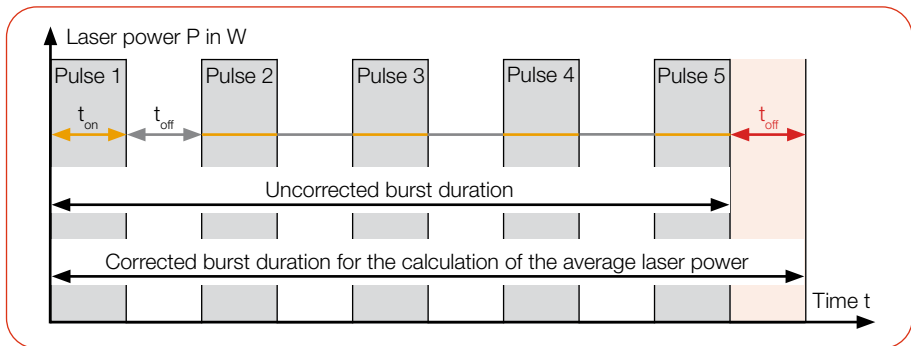

Fig. 9.4: Uncorrected and corrected burst duration with pulsed lasers

## 10 Measure

### 10.1 Warning messages



#### **DANGER**

##### **Serious eye or skin injury due to laser radiation**

If the device is moved from its aligned position, increased scattered or directed reflection of the laser beam can occur during measuring operation (laser class 4).

- ▶ Mount the device in such a way that it cannot be moved by an unintended push or a pull on the cables.



#### **DANGER**

##### **Serious eye or skin injury due to laser radiation**

During the measurement the laser beam is guided on the device, which causes scattered or directed reflection of the laser beam (laser class 4). The reflected beam is usually not visible.

- ▶ Please wear safety goggles adapted to the power, power density, laser wave length and operating mode of the laser beam source in use.
- ▶ Wear suitable protective clothing and protective gloves.
- ▶ Protect yourself from laser radiation by separating protective devices (e.g. by using appropriate shielding).

#### **NOTICE**

##### **Damaging/Destruction of the device**

The maximum permissible energy per laser pulse depends on various variables, including the absorber temperature.

- ▶ Please observe the limit values and dependencies specified in chapter 15 „Technical data“ on page 65 before the measurement.

**NOTICE****Damaging/Destruction of the device**

Contamination and fingerprints on the protective window can cause damage or cracking respectively splintering of the protective window during measuring operation.

- ▶ Do not touch the protective window with bare hands.
- ▶ Regularly check the condition of the protective window. The protective window can be cleaned or replaced in case of heavy, non-removable contamination (see chapter 12 „Maintenance and service“ on page 58).
- ▶ Only operate the device with a clean protective window.

**NOTICE****Damaging/Destruction of the device**

The alignment tool will be destroyed by laser radiation.







- ▶ Remove the alignment tool before switching on the laser.

## 10.2 Measuring with the Cube M

Please read chapter 9 „Laser parameter setting“ on page 30 first.

### 10.2.1 Start measurement

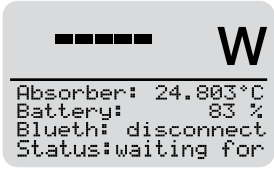
Measurements with the Cube M are to be performed exclusively with a stationary laser beam.

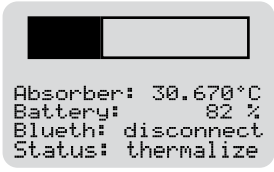
<ol style="list-style-type: none"> <li>1. Observe the warning messages in chapter 10.1 on page 35.</li> </ol>	
<ol style="list-style-type: none"> <li>2. Press the On/Off button.</li> </ol>	
<p> The start screen displays:</p> <ul style="list-style-type: none"> <li>• The firmware version.</li> <li>• The calibrated wavelength.</li> </ul>	
<p> After approx. 5 seconds, the device is ready for operation.</p>	
<ol style="list-style-type: none"> <li>3. Switch on the laser.</li> </ol> <p>➔ The measurement is started automatically when the laser is switched on.</p>	<p>For a high measurement accuracy, we recommend an energy input of 300 J per measurement (see chapter 9.3 on page 32).</p>
<p> The thermalization is displayed by means of a progress bar (duration approx. 4 seconds). A measuring cycle (measure, thermalize, send data) takes approx. 10 seconds. The device is then ready for a new measurement.</p>	

 The screen displays the following measurement values:

- Laser power in W <sup>1)</sup>
- Absorber temperature in °C
- Pulse duration/burst duration in ms <sup>1)</sup>

<sup>1)</sup> For cw lasers, the measured power of the laser is displayed in W (Power) and the pulse duration in ms (Time).

For pulsed lasers, the measured average power of the laser is displayed in W (Power) over the burst duration (corrected) in ms (Time).

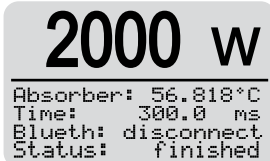

4. To access the following screen, press the On/Off button for approx. 2 seconds.



 Further pulse parameters are displayed:

- Total pulse duration in ms (Ontime)
- Total pulse pause in ms (Offtime)
- Uncorrected burst duration in ms (uBurst)
- Number of pulses (Pulses)
- Max. Power of a pulse in W (Pk Pow)
- Average power in W (Av Pow)
- Energy in J

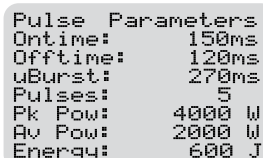



Further information on measuring with pulsed lasers can be found in chapter 9.5 on page 34.

By default, the device switches off automatically after approx. 10 minutes. The power-off time of the device can be set via the LDS or the Cube App (see section „Power saving functions“ in chapter 10.3.3 „Settings in the device control“ on page 43).

You can also switch off the device manually by keeping the On/Off button pressed for approx. 5 seconds.

### 10.2.2 Display of measurement results

The last 14 measurement values are displayed directly on the screen. The latest measurement is always displayed with the counter “Nr. 1”.

<ol style="list-style-type: none"> <li>To access the following screen, press the On/Off button for approx. 2 seconds.</li> </ol>																									
<p> The measured average laser power <sup>1)</sup> (Power) and pulse duration/burst duration <sup>1)</sup> (Time) are displayed.</p> <ol style="list-style-type: none"> <li>Press the On/Off button again for 2 seconds to have the remaining measuring values (no. 8-14) displayed.</li> </ol> <p><sup>1)</sup> For cw lasers, the measured power of the laser is displayed in W (Power) and the pulse duration in ms (Time). For pulsed lasers, the measured average power of the laser is displayed in W (Power) over the burst duration (corrected) in ms (Time).</p>	<table border="1"> <thead> <tr> <th>Nr</th> <th>Power</th> <th>Time 1</th> </tr> </thead> <tbody> <tr><td>1</td><td>2000.0</td><td>300.0</td></tr> <tr><td>2</td><td>912.1</td><td>333.4</td></tr> <tr><td>3</td><td>812.2</td><td>375.3</td></tr> <tr><td>4</td><td>712.5</td><td>428.9</td></tr> <tr><td>5</td><td>611.8</td><td>500.3</td></tr> <tr><td>6</td><td>511.1</td><td>600.4</td></tr> <tr><td>7</td><td>408.0</td><td>750.3</td></tr> </tbody> </table>	Nr	Power	Time 1	1	2000.0	300.0	2	912.1	333.4	3	812.2	375.3	4	712.5	428.9	5	611.8	500.3	6	511.1	600.4	7	408.0	750.3
Nr	Power	Time 1																							
1	2000.0	300.0																							
2	912.1	333.4																							
3	812.2	375.3																							
4	712.5	428.9																							
5	611.8	500.3																							
6	511.1	600.4																							
7	408.0	750.3																							

You can read out the last 30 measurements with the optional Android™ PRIMES Cube App for mobile devices or the optional LDS.



## 10.3 Measuring with the optional LaserDiagnosticsSoftware LDS

Please read chapter 9 „Laser parameter setting“ on page 30 first.

This chapter describes measurements with the LDS. For a detailed description of the software installation, file management and evaluation of the measured data, please refer to the separate operating manual “LDS”.

### 10.3.1 Connect/disconnect the device with the LDS

#### Switch on the device and connect it to the LDS

1. Observe the warning messages in chapter 10.1 on page 35.
2. Press the On/Off button  on the device.
3. Connect the USB cable to the Micro-USB port on the device and with the PC or  
Connect the device to the PC via Bluetooth® (see chapter 8.3.3 on page 27).
4. Start the LDS by double-clicking on the program icon  in the start menu group or on the desktop icon.

 The start screen is displayed.

5. Select the operating mode **Measure**.

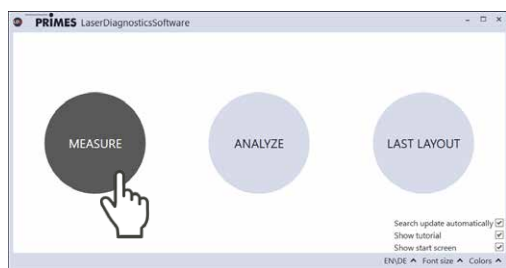

If the **Show start screen** option is disabled or the window **Connections** is closed:

- ▶ Click the **Devices** tab and then the + **Connect to device** button.

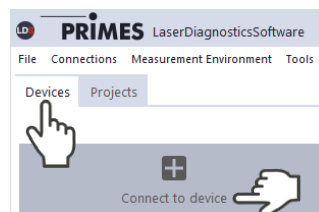



 The **Connections** window is displayed.

6. Click on the desired device.
7. Click the **Connect to device** button.

**If the device does not appear:**

- ▶ Install the USB driver according to chapter 8.2.2 on page 26.
- ▶ Check according to chapter 8.3.2 on page 27 whether Bluetooth® is available and activated on your PC.

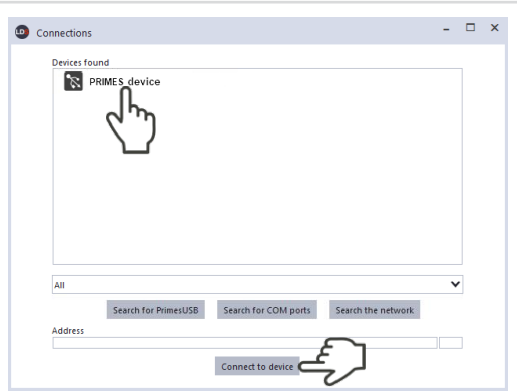

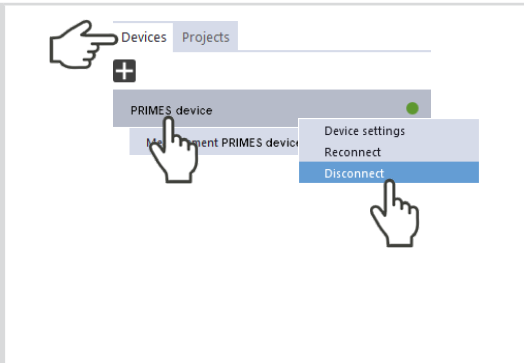

**Disconnect device from the LDS and switch off**

1. Click the **Devices** tab.
2. Right-click the device and select the **Disconnect** menu point.
  - ▶ The device is disconnected from the LDS.
3. Press the On/Off button  on the device for 5 seconds.
  - ▶ The device is switched off.
4. If necessary, disconnect the electrical connections.





## 10.3.2 Open toolbench Cube Measurement

 The Cube M is established as a connected device.

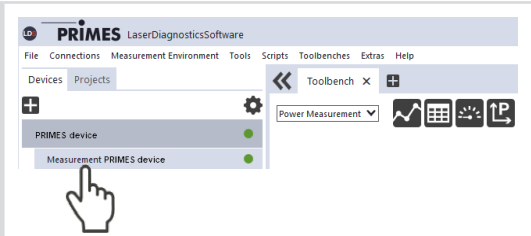
 Click on the connected device.



 The corresponding **Device control** opens.

 The toolbench **Cube Measurement** is opened.

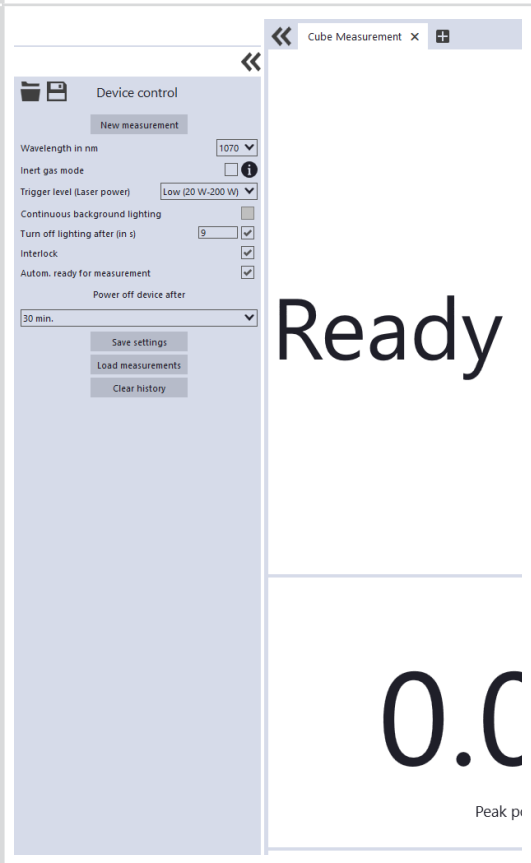

If the **Cube Measurement** toolbench was previously closed, the **Open measurement toolbench** button is displayed.

Click this button to open the toolbench again.



### 10.3.3 Settings in the device control

Edit the options according to the explanations in the following table.

Option	Explanation
<b>Open measurement toolbench</b>	If the <b>Cube Measurement</b> toolbench was previously closed, the <b>Open measurement toolbench</b> button is displayed. ► Click the button to reopen the <b>Cube Measurement</b> toolbench.
<b>New measurement</b>	► Click this button to create a new <b>series</b> in the project tree. The measurement starts when the laser is switched on.
<b>Wavelength in nm</b>	The Cube M can measure the laser power of lasers with a wavelength between 1 030 – 1 090 nm. The calibrated wavelength of 1 070 nm is preset.
<b>Inert gas mode</b>	<p>The <b>inert gas mode</b> is integrated in the Cube M from firmware version 5.2. To use the <b>inert gas mode</b>, the optional LDS, version 1.4 or higher must be installed on the PC.</p> <p>With the <b>inert gas mode</b>, the possible influence of the thermal conductivity of the gas used on the measurement process is typically reduced by 2/3.</p> <p>Particular attention was given to the gases helium and argon, which have significantly reduced thermal conductivity in relation to air (78 % nitrogen and 21 % oxygen).</p> ► Set the check mark to enable the option. <div style="background-color: #f0f0f0; padding: 10px; margin-top: 10px;"> <p> The <b>inert gas mode</b> is not suitable for using the Cube M within a nitrogen atmosphere. Only use the <b>inert gas mode</b> when using the device e.g. in helium or argon.</p> <p>If the <b>inert gas mode</b> is activated when using the Cube M in air, there may be reduced measurement accuracy in the power measurement.</p> </div> <div style="background-color: #f0f0f0; padding: 10px; margin-top: 10px;"> <p> The <b>inert gas mode</b> is recalculating the values measured by the Cube M. However, the values are not transferred back to the Cube M.</p> <p>The display in the LDS will therefore deviate from the conventionally determined measured values in the Cube M when the <b>inert gas mode</b> is active.</p> </div>

Tab. 10.1: Settings in the device control

Option	Explanation
<p><b>Trigger level (Laser power)</b></p>	<p>Setting the trigger level enables the sensitivity of the built-in photodiode to be adjusted:</p> <ul style="list-style-type: none"> <li>• The <b>Trigger level Low</b> setting is recommended for measuring low laser powers and pulsed laser beams.</li> <li>• The <b>Trigger level High</b> setting prevents false triggering due to environmental influences.</li> </ul> <div style="border: 1px solid #ccc; padding: 10px; margin: 10px 0;"> <p> If the <b>Trigger level</b> is set too low, a measurement can be triggered even without a laser beam. If the <b>Trigger level</b> is set too high, no measurement can be triggered.</p> <p>▶ Set the <b>Trigger level</b> to a higher/lower value.</p> </div> <p>In the Cube M the <b>Trigger level Low (20 W-200 W)</b> is preset.</p> <ol style="list-style-type: none"> <li>1. Select the <b>Trigger level</b> in the drop-down list.</li> <li>2. Click the <b>Save settings</b> button.</li> </ol>

### Power saving functions

<p><b>Continuous background lighting</b></p>	<p>The option switches the background lighting of the display in the Cube M on or off. The setting is only possible with deselected option <b>Turn off lighting after (in s)</b>.</p> <ol style="list-style-type: none"> <li>1. Set the check mark to enable the option.</li> <li>2. Click the <b>Save settings</b> button.</li> </ol>
<p><b>Turn off lighting after (in s)</b></p>	<p>The option switches the background lighting of the display in the Cube M after the set time off. The setting is only possible with deselected option <b>Continuous background lighting</b>.</p> <ol style="list-style-type: none"> <li>1. Enter the time in seconds.</li> <li>2. Click the <b>Save settings</b> button.</li> </ol>
<p><b>Interlock</b></p>	<p>The option switches the safety interlock on or off. For safety reasons, switching off the safety interlock is not recommended.</p> <ol style="list-style-type: none"> <li>1. Set the check mark to switch on the safety interlock.</li> <li>2. Click the <b>Save settings</b> button.</li> </ol>

Tab. 10.1: Settings in the device control

Option	Explanation
<b><i>Autom. ready for measurement</i></b>	<p>The option automatically puts the device back into ready for measurement after each measurement. If the check mark has been removed, the device must be set to ready for measurement again after each measurement by briefly pressing the On/Off button.</p> <ol style="list-style-type: none"> <li>1. Set the check mark to enable the option.</li> <li>2. Click the <b>Save settings</b> button.</li> </ol>
<b><i>Power off device after</i></b>	<p>The option is used to set the time in minutes after which the device switches off automatically. By default, the device switches off automatically after approx. 10 minutes.</p> <div data-bbox="349 571 1001 671" style="background-color: #f0f0f0; padding: 10px; border: 1px solid #ccc;"> <p> When a charging cable is connected, the device cannot be switched off automatically. The device is then permanently ready for measurement.</p> </div> <ol style="list-style-type: none"> <li>1. Select the time in minutes from the drop-down list.</li> <li>2. Click the <b>Save settings</b> button.</li> </ol>
<b><i>Save settings</i></b>	By pressing the button, the selected settings are transferred to the Cube M.
<b><i>Load measurements</i></b>	By pressing the button, the last 30 measurements stored in the device are read out from the Cube M memory.
<b><i>Clear history</i></b>	By pressing the button, the measurements stored in the Cube M are deleted.

Tab. 10.1: Settings in the device control

## 10.3.4 Start measurement

Measurements with the Cube M are to be performed exclusively with a stationary laser beam.

The measurement in the Cube M starts automatically when the laser is switched on. The **Start** display field is therefore not active.

A measuring cycle (measure, thermalize, send data) takes approx. 10 seconds. The device is then ready for a new measurement.

To create a new series in the project tree, press the **New measurement** button.

If the setting **Autom. ready for measurement** is deactivated, briefly press the On/Off button on the device.

1. Observe the warning messages in chapter 10.1 on page 35.
  2. Enter the settings for the **Inert gas mode** and the **Trigger level** in the **device control** as described in chapter 10.3.3 „Settings in the device control“ on page 43.
  3. Confirm the selection of a **Trigger level** by clicking the **Save settings** button.
  4. Switch on the laser.
- 👁️ The progress of the measurement is indicated in the **Measurement is running** and then **Measurement is finished** displays.
5. Switch off the laser.

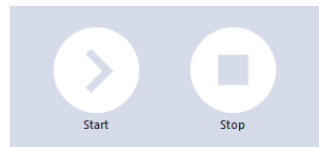
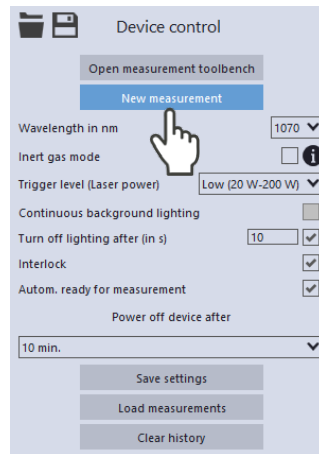



### Status

- Ready for measurement
- Measurement is running
- Measurement finished

### 10.3.5 Measuring results display

#### Display the current measurement in the toolbench Cube Measurement

 After the measurement is finished, the measurement results are displayed in the open toolbench **Cube measurement** (see below).

For all tools, the displayed parameters can be adjusted by clicking the gear symbol .

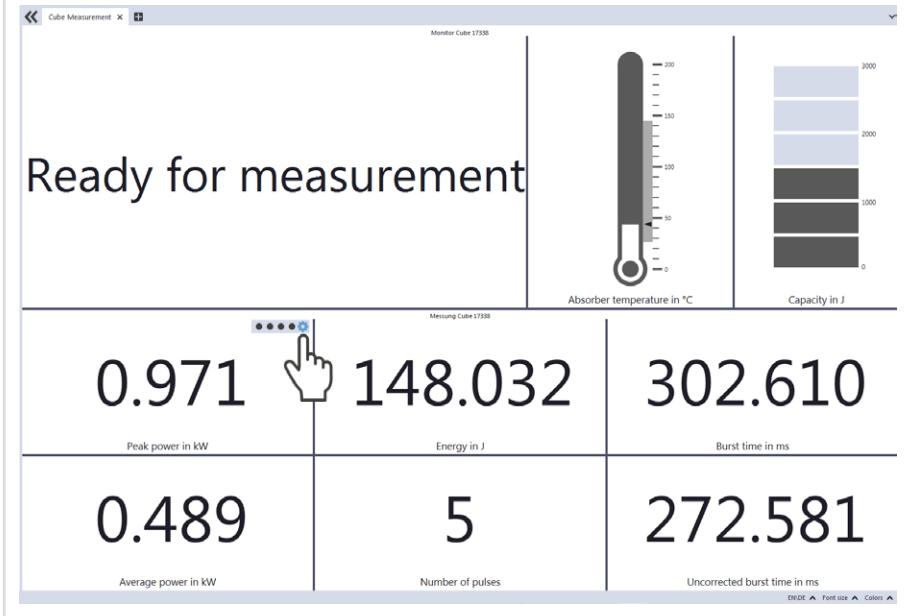

## Display of the measurements stored in the Cube M

1. Press the **Load measurements** button
  - ➔ The last 30 measurements stored in the device are read out of the memory of the Cube M.

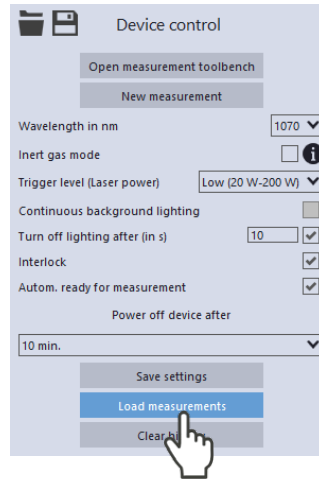

2. Switch to the **Projects** tab.
  - 👁 The uploaded measurements are displayed in the project tree.

### Date, time and order of the displayed measurements:

3. Move the mouse pointer over the measurement.
  - 👁 The window displays the date and time of the upload.
  - 👁 Uploaded measurements are displayed in a descending order (last/most recent measurement is referred „measurement 0“).

### Evaluate measured values with the LDS tools:

See section „Evaluate measured values with the LDS tools“ on page 50.

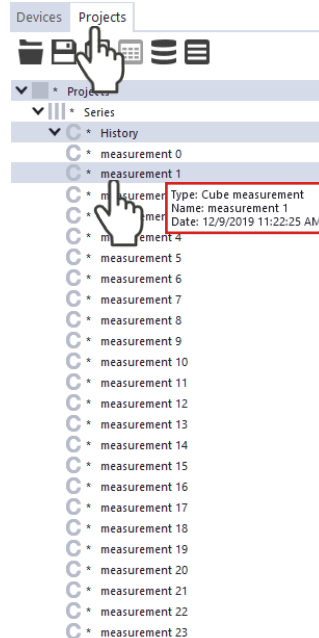



### Display of the measurements performed with the LDS

1. Switch to the **Projects** tab.

The measurements are displayed in the project tree.

#### Date, time and order of the displayed measurements:

2. Move the mouse pointer over the measurement.

The window displays the date and time of the measurement.

When measuring with the LDS, the measurements are displayed with increasing numbering (last/current measurement has the highest value).

#### Evaluate measured values with the LDS tools:

See section „Evaluate measured values with the LDS tools“ on page 50.

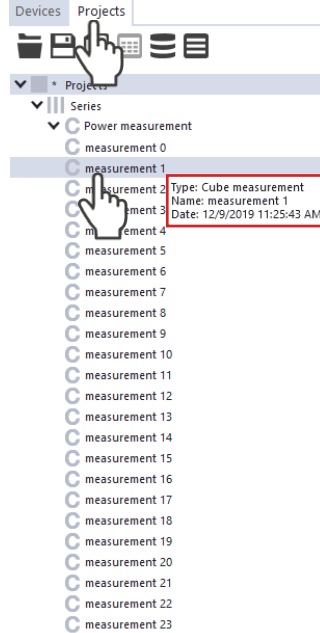

#### When using the inert gas mode:

In the project tree, the used **Inert gas mode** is indicated.

- ▶ Move the mouse pointer over the measurement.

**Inert gas mode was used** is displayed in the window.

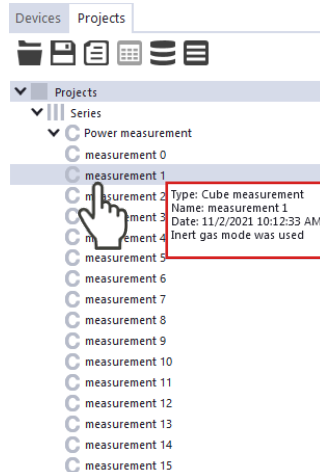

## Evaluate measured values with the LDS tools

1. Click the **Power measurement** selection in the drop-down list.  
 The **Graph**, **Results table** and **Measurement value display** tools are displayed.  
 The **Power measurement** tool is not relevant for the Cube M.
2. Open the desired tool and drag and drop the measurements from the project tree into the opened tool.

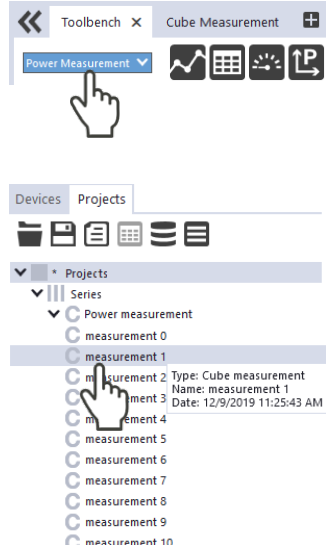

For all tools, the displayed parameters can be adjusted by clicking the gear symbol . For example, the rows/columns in the **Results table** can be swapped.

For uploaded measurements from the Cube M, the numbering is descending (last/most recent measurement is referred „measurement 0“). When measuring with the LDS, the measurements are displayed with increasing numbering (last/current measurement has the highest value).

The “Help”-function of the LDS can be accessed by clicking on the question mark in the toolbar of the tool windows.

For a detailed description of the software installation, file management and evaluation of the measured data, please refer to the separate operating manual “LDS”.

The screenshot shows the software interface with the following components:

- Graph: History:** A line graph showing Power in W (Y-axis, 0 to 400) versus Index (X-axis, 0 to 30). The data series is labeled "Series: History Power".
- Measurement Value Display: me...:** A large display showing the value **391.119** with the label "Power in W" below it.
- Results Table: History:** A table with columns: Number of pulses, Energy in J, Power in W, Peak power in W, and Uncorrected burst time in ms. The table contains 18 rows of measurement data. A hand icon points to the gear icon in the table's toolbar.
- Parameter Display Panel:** A panel on the right with various settings:
  - Number of decimal places: -1
  - Number of points: 0
  - Show legend:
  - Buttons: "Switch rows/columns" and "Export to file (.csv)" (with a hand icon pointing to it).
  - Complete section:
    - $\Delta T$  Absorber
    - Absorber temperature
    - Average power
    - Burst time
    - Capacity
    - Energy
    - Number of pulses
    - Offtime
    - Ontime
    - Peak power
    - Power
    - Uncorrected average power
    - Uncorrected burst time

### 10.3.6 Delete measurements from the memory of the Cube M

The Cube M stores the measurements in an internal memory.

- ▶ Click the **Clear history** button.
- ▶ The measurements in the Cube M are deleted.

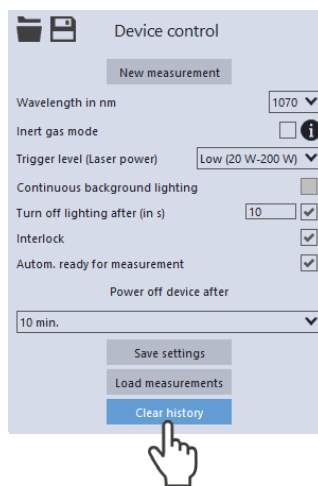

## 10.4 Measuring with the optional Cube App

With the Cube App for mobile devices with Android™ you can operate and evaluate the device via a smartphone/tablet.

The Cube App is available free of charge in the Google Play Store/Apps. You need a valid Google account. In the search field of the Google Play Store, enter the search term "Primes cube app".

A Bluetooth® connection with the device makes it possible to read out and graphically display the measured values (laser power, pulse duration, and energy per pulse) with the mobile end device. The Cube App also shows an overview of the device status (temperature, charge status, status notifications).

In the Cube App you can make additional settings for power saving functions and the automatic ready for measurement.

Please find detailed information on the operation of the Cube App in the separate operating manual Cube App. These can be found on the PRIMES website at:

**<https://www.primes.de/en/support/downloads/operating-manuals.html>**

## 11 Troubleshooting

### 11.1 Messages in the LaserDiagnosticsSoftware LDS during measurement

If problems occur during a measurement, the LDS displays them in different categories and different colors.

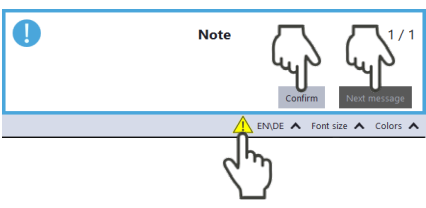
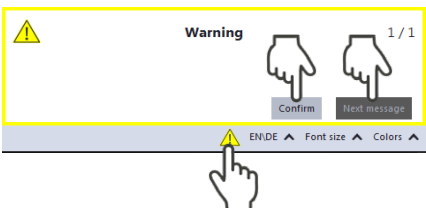
<p><b>Notes</b></p> <p>Notes provide assistance in interpreting the measurement results and are displayed in a blue window.</p> <p>Use one of the following options:</p> <ul style="list-style-type: none"> <li>▶ Click on the warning triangle in the footer to display/hide the window.</li> <li>▶ If applicable, click the <b>Next message</b> button to display more messages of the same category.</li> <li>▶ Click the <b>Confirm</b> button to remove the displayed message.</li> </ul>	
<p><b>Warnings</b></p> <p>Non-safety-critical problems that influence the quality of the measurement results, for example, are displayed in a yellow window.</p> <p>Use one of the following options:</p> <ul style="list-style-type: none"> <li>▶ Click on the warning triangle in the footer to display/hide the window.</li> <li>▶ If applicable, click the <b>Next message</b> button to display more messages of the same category.</li> <li>▶ Click the <b>Confirm</b> button to remove the displayed message.</li> </ul>	

## Device errors

Device errors that can result in damage of the device are displayed in an orange window.

In this case, proceed as follows:

1. Fix the problem.
  2. Click the **Confirm** button to remove the message.
- 👁️ The message disappears. If the problem is not fixed, then the message appears again shortly afterwards.
3. Do not proceed with the measurement until the problem is solved.

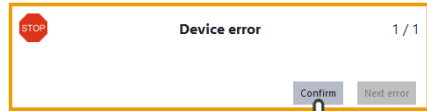

## Safety critical device errors

Safety-critical problems that can result in damage/destruction of the device are displayed in a red window.

In this case, proceed as follows:

1. Fix the problem immediately.
  2. Click the **Confirm** button to remove the message.
- 👁️ The message disappears. If the problem is not fixed, then the message appears again shortly afterwards.
3. Do not proceed with the measurement until the problem is solved.

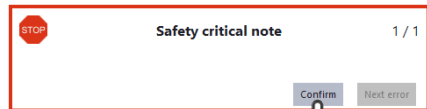

## 11.2 Connection failure with the LDS

Error	Possible cause	Solution
The Bluetooth® connection between the device and the LDS cannot be established.	No Bluetooth® connection is established.	▶ Connect the device to the PC according to chapter 8.3.3 on page 27.
	Bluetooth® of the PC is not activated.	▶ Activate Bluetooth® according to chapter 8.3.2 on page 27.
	No Bluetooth® dongle is connected to the PC.	In chapter 8.3.1 on page 27 you will find a recommendation for a Bluetooth® dongle.
The USB connection between the device and the LDS cannot be established.	No USB connection is established.	▶ Connect the USB cable to the Micro-USB port on the device and with the PC.
	The PRIMES USB driver was not installed.	A driver in the PC is required for a USB connection to the device. ▶ Install the USB driver according to chapter 8.2.2 on page 26.

Tab. 11.1: Connection failure with the LDS

## 11.3 Other errors

Error	Possible cause	Solution
A measurement is started without the laser beam switched on.	The <b>Trigger level</b> is set too low.	In the Cube M the <b>Trigger level Low (20 W-200 W)</b> is preset.  <ol style="list-style-type: none"> <li>1. Select a higher <b>Trigger level</b> in the drop-down list.</li> <li>2. Click the <b>Save settings</b> button.</li> </ol>
A measurement cannot be triggered.	The <b>Trigger level</b> is set too high.	<ol style="list-style-type: none"> <li>1. Select a lower <b>Trigger level</b> in the drop-down list.</li> <li>2. Click the <b>Save settings</b> button.</li> </ol>

Tab. 11.2: Other errors

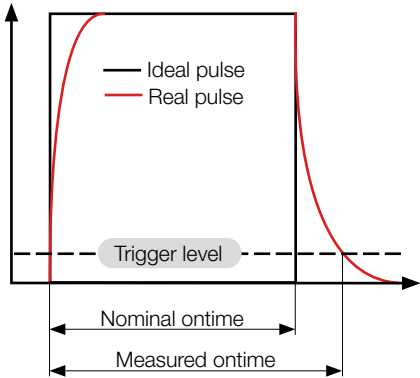
Error	Possible cause	Solution
A pulsed laser beam cannot be measured.	Not enough energy is put into the absorber.	<p>When using pulsed laser radiation a correct exposure time measurement is possible up to a pulse frequency of 10 kHz and a duty cycle of 50 %. In case of ontimes/offtimes shorter than 50 <math>\mu</math>s a correct exposure time measurement is not possible.</p> <ul style="list-style-type: none"> <li>▶ Observe the min. ontime/offtime (duty cycle) for pulsed lasers of 50 <math>\mu</math>s (e.g. max. 10 kHz at 50 % duty cycle).</li> </ul>
Too many pulses are displayed.	Additional erroneous pulses (needle tips from ns to $\mu$ s duration).	<ul style="list-style-type: none"> <li>▶ Select a different <b>Trigger level</b> from the drop-down list.</li> </ul>
The measured ontime is longer than the set nominal ontime.	The real pulse does not correspond to an ideal square wave signal.	 <ul style="list-style-type: none"> <li>▶ Select a higher <b>Trigger level</b> from the drop-down list.</li> </ul>

Tab. 11.2: Other errors



Error	Possible cause	Solution
Too little laser power is displayed.	The beam diameter at the inlet aperture is too large.	<ul style="list-style-type: none"> <li>▶ Align the device according to chapter 7.2.3 on page 19 again.</li> </ul>
	The laser beam hits the inlet aperture only partially.	
	The laser rise time exceeds 1 % of the irradiation time.	<p>Detailed information on the laser rise time can be found in chapter 9.1 on page 30.</p> <ul style="list-style-type: none"> <li>▶ Set the shortest possible laser rise time.</li> </ul>
	The set laser power does not correspond to the actual emitted laser power.	<p>When properly aligned and used, the calibrated PRIMES measuring device provides reliable measured values.</p> <ul style="list-style-type: none"> <li>▶ Increase the set power on the laser.</li> <li>▶ Repeat the power measurement.</li> </ul>

Tab. 11.2: Other errors

## 12 Maintenance and service

### 12.1 Maintenance intervals

The operator is responsible for determining the maintenance intervals of the measuring device. PRIMES recommends a maintenance interval of 12 months for inspection and calibration.

If the device is used sporadically (less than once a day), the maintenance interval can be extended up to 24 months.

Please note that the safety and warning functions of the device must be checked regularly.

### 12.2 Cleaning

#### 12.2.1 Cleaning the device surface

1. After a measurement let the device cool down for an adequate period of time.
2. First clean the device surface with clean and oil-free compressed air.
3. Close all device openings.
4. For further cleaning, use a mixture of distilled water and isopropanol in a ratio of approx. 5:1.  
Use lint-free cleaning cloths that do not cause scratches.
5. If these steps are not sufficient, please contact PRIMES or your PRIMES distributor.

#### 12.2.2 Cleaning the protective window

1. After a measurement let the device cool down for an adequate period of time.
2. Dismount the protective window according to chapter 12.3.2 on page 61, sections 1-6.
3. First clean the protective window with cleaned, oil-free compressed air.
4. For further cleaning, use isopropanol (observe the manufacturer's safety instructions).  
The coating of the protective window is particularly sensitive to scratches. Use cloths suitable for cleaning protective glasses.
5. Replace the protective window with a new one if the contamination cannot be removed or if it is damaged.
6. Mount the protective window according to chapter 12.3.2 on page 61, sections 7-11.

### 12.3 Exchanging the protective window on the device

The protective window in the beam entrance is a wearing part and can be replaced if necessary.



The protective window is coated with an anti-reflective coating and has low reflectance values of less than 1 %. To avoid increased reflection, use only original PRIMES protective windows.

Protective window diameter 30 mm

Glass thickness 1.5 mm

Order number 801-004-054 (1 piece); 410-011-022 (10 pieces)

### 12.3.1 Warning messages



#### **DANGER**

##### **Serious eye or skin injury due to laser radiation**

If the protective window is not correctly positioned, reflections can cause directional laser radiation.

- ▶ Ensure that the protective window is positioned evenly in the indentation on the O-ring.



#### **CAUTION**

##### **Burns due to hot components**

The protective window and the optics under the protective window are hot after a measurement.

- ▶ Do not clean or change the protective window directly after a measurement.
- ▶ Let the device cool down for an adequate period of time.

#### **NOTICE**

##### **Damaging/Destruction of the device**

Contamination and fingerprints on the protective window can cause damage or cracking respectively splintering of the protective window during measuring operation.

- ▶ Only clean or change the protective window in a dust-free environment.
- ▶ Do not touch the protective window with bare hands.  
Do not touch the optics.
- ▶ When exchanging the protective window wear suitable gloves.

#### **NOTICE**

##### **Damage to the optics**

Contamination on the optics causes a measurement deviation during laser irradiation due to absorption and can damage the optics.

- ▶ Ensure during exchanging the protective window that the subjacent optics will not be contaminated.

### 12.3.2 Exchanging the protective window

1. Observe the warning messages in 12.3.1 on page 60.
2. Let the device cool down for an adequate period of time.
3. Put on suitable gloves.
4. Unscrew the 3 Torx screws M2.5 x 4 mm on the protective window mount.
5. Place the device as shown in Fig. 12.1 on page 61 and carefully remove the protective window mount upwards.  
Make sure that the inserted O-ring does not fall out of the device.
6. Remove the protective window from the device.
7. Check the cleaned or a new protective window for contamination.
8. Insert the protective window into the device.  
Ensure that the inserted O-ring is not out of place.
9. Place the protective window mount according to Fig. 12.1 on page 61.
10. Tighten the protective window mount with 3 Torx screws M2.5 x 4 mm.
11. Check for secure fit of the protective window mount.  
The protective window mount must rest flat on the device.

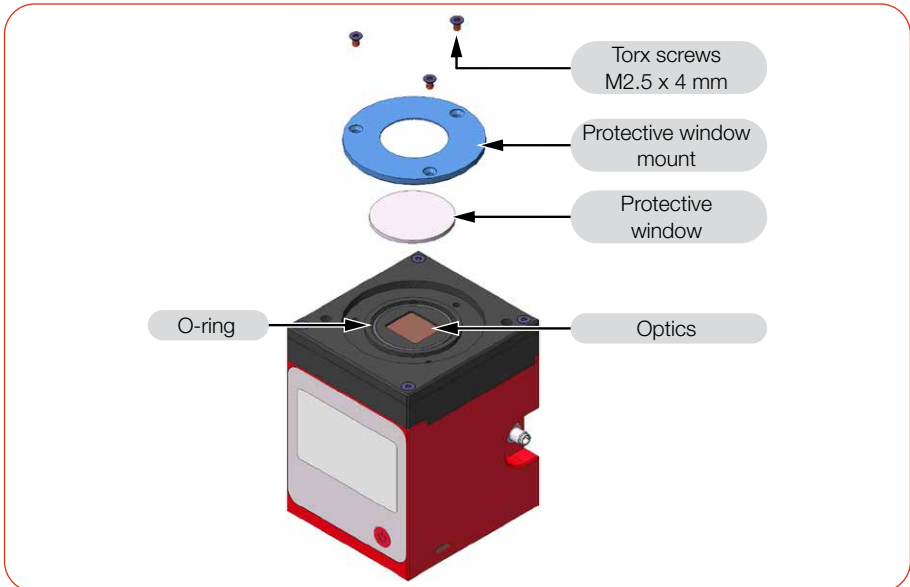

Fig. 12.1: Exchanging the protective window

## 13 Measures for the product disposal

As a B2B device, this PRIMES measuring device is subject to the European Waste Electrical and Electronic Equipment (WEEE) Directive and the corresponding national laws. The WEEE directive obliges the operating company to dispose of the device in an environmentally sound manner, not with household waste, but in a separate WEEE collection.

PRIMES gives you the opportunity to return your PRIMES measuring device for free disposal within the scope of the Waste of Electrical and Electronic Equipment (WEEE Directive). This service does not include shipping costs. You can send PRIMES measuring devices to be disposed of within the EU to our address:

PRIMES GmbH  
Max-Planck-Str. 2  
64319 Pfungstadt  
Germany

If you are located outside the EU, please contact your local PRIMES distributor to discuss the disposal procedure for your PRIMES measuring device.

PRIMES is registered at the German „joint body“ for producers „Stiftung Elektro-Altgeräte Register“ (Stiftung EAR). Our number is: WEEE-reg.-no. DE65549202.

### **Caution battery included!**

Please note that there is a permanently installed lithium-battery in the device. This must be disposed of in accordance with applicable national and international laws if the device is not returned to PRIMES.

If you need more information on how to safely remove the battery for final disposal, please contact us at: [\*\*info@primes.de\*\*](mailto:info@primes.de)

## 14 Declaration of conformity

### Original EG Declaration of Conformity

The manufacturer: PRIMES GmbH, Max-Planck-Straße 2, 64319 Pfungstadt, Germany,  
hereby declares that the device with the designation:

**Cube**

**Types: Cube, Cube M, Cube L, Cube L1**

is in conformity with the following relevant EC Directives:

- EMC Directive EMC 2014/30/EU
- Low voltage Directive 2014/35/EU
- Directive 2011/65/EC on the restriction of the use of certain hazardous substances (RoHS) in electrical and electronic equipment
- Radio Equipment Directive 2014/53/EU

Authorized for the documentation:  
PRIMES GmbH, Max-Planck-Straße 2, 64319 Pfungstadt, Germany

The manufacturer obligates himself to provide the national authority in charge with technical documents in response to a duly substantiated request within an adequate period of time.

Pfungstadt, June 29, 2022

---

Dr. Reinhard Kramer, CEO

## UKCA Declaration of Conformity

The manufacturer: PRIMES GmbH, Max-Planck-Straße 2, 64319 Pfungstadt, Germany,  
hereby declares that the device with the designation:

### **Cube**

**Types: Cube, Cube M, Cube L, Cube L1**

is in conformity with the following relevant UK Regulations:

- Electromagnetic Compatibility Regulations 2016
- Electrical Equipment (Safety) Regulations 2016
- The Restriction of the Use of Certain Hazardous Substances in  
Electrical and Electronic Equipment Regulations 2012
- Radio Equipment Regulations 2017

Authorized for the documentation:  
PRIMES GmbH, Max-Planck-Straße 2, 64319 Pfungstadt, Germany

The manufacturer obligates himself to provide the national authority in charge with technical documents in response to a duly substantiated request within an adequate period of time.

Pfungstadt, June 29, 2022

  
\_\_\_\_\_  
Dr. Reinhard Kramer, CEO



## 15 Technical data

Measurement parameters	Cube M A
Power range	25 – 2 000 W <sup>1)</sup>
Wavelength range (see identification plate)	1 030 – 1 090 nm
Beam diameter on the protective window	1 – 4 mm
Max. power density on the protective window	250 kW/cm <sup>2</sup>
Irradiation time	0.1 – 2.0 s <sup>1)</sup> (depending on laser power)
Min. ontime/offtime (duty cycle) for pulsed lasers	50 µs (e.g. max. 10 kHz at 50 % duty cycle)
Max. laser rise time	< 1 % of irradiation time
Energy per measurement	50 – 3 000 J
Recommended energy per measurement	300 – 500 J
Total duration until measurement value output	< 10 s
Nominal measurement frequency	300 J: 1 cycle/min 3 000 J: 1 cycle/15 min
<sup>1)</sup> The stated limit values are to be understood in correlation with the permitted maximum energy (E = P · t).	
Device parameters	
Max. absorber temperature	120 °C
Max. angle of incidence perpendicular to inlet aperture	± 20°
Max. centered tolerance	± 2.0 mm
Max. beam divergence (full angle) at an angle of incidence of 0°/20°	300 mrad/30 mrad
Accuracy	
Angle of incidence up to 10°	± 3 %
Angle of incidence from 10° to 20°	± 5 %
Reproducibility	± 1 %

Supply Data	Cube M A
Power supply	Built-in lithium-ion battery
Maximum charging current	1.3 A
Voltage	3.7 V
Capacity	1 000 mAh
Energy	3.7 Wh
Weight of the battery	20 g
Shipment classification	Lithium ion batteries contained in equipment
Temperature range for charging the lithium-ion battery	0 – 45 °C
Communication	
Interfaces	USB/Bluetooth®
Software (optional)	Cube App and LaserDiagnosticsSoftware LDS
Dimensions and Weight	
Dimensions (LxWxH) (without connections)	60 x 65 x 80 mm
Weight (approx.)	800 g
Environmental conditions	
Operating temperature range	15 – 40 °C
Storage temperature range	5 – 50 °C
Reference temperature	22 °C
Permissible relative humidity (non-condensing)	10 – 80 %

## 16 Dimensions

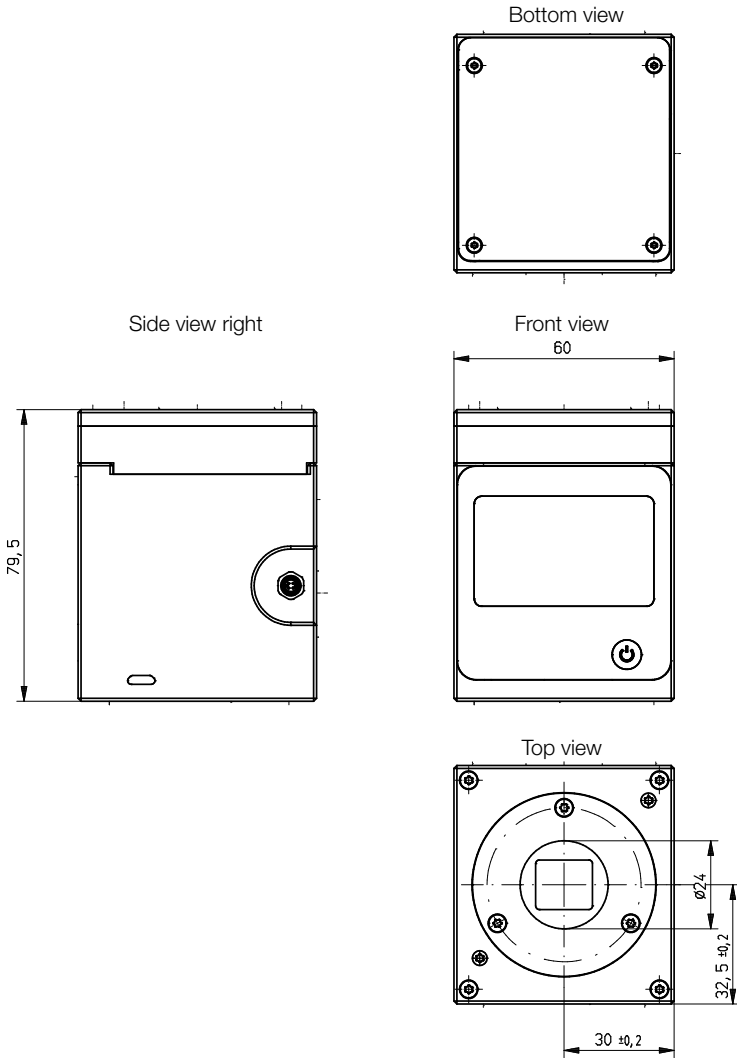

Dimensions in mm

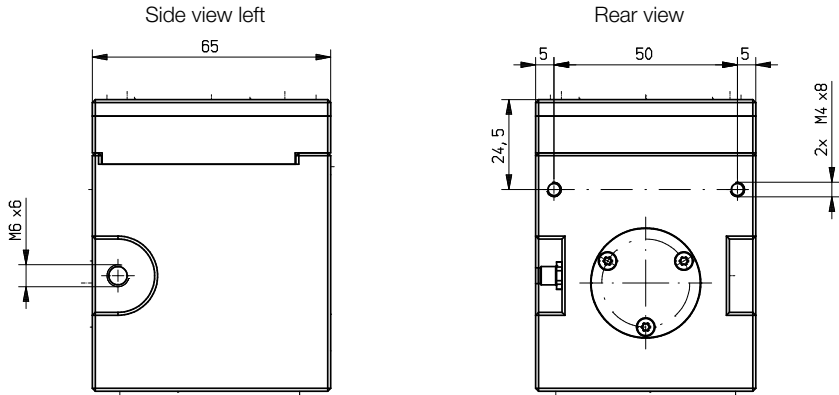

Dimensions in mm

## 17 Appendix

### A GNU GPL license notice

The software of this product contains software code that is licensed subject to the GNU General Public License (GPL) Version 2 or later. The license terms of the GNU GPL Version 2 or later are available on the following websites:

- <https://www.gnu.org/licenses/old-licenses/gpl-2.0.en.html>
- <https://www.gnu.org/licenses/licenses.en.html>





PRIMES GmbH  
Max-Planck-Str. 2  
64319 Pfungstadt  
Germany

Tel +49 6157 9878-0  
[info@primes.de](mailto:info@primes.de)  
[www.primes.de](http://www.primes.de)