

Original Instructions



FocusMonitor FMW+

LaserDiagnosticsSoftware LDS

IMPORTANT!

READ CAREFULLY BEFORE USE.

KEEP FOR FUTURE USE.

Table of contents

1	Basic safety notes	7
2	Icons and conventions	10
3	About this operating manual	11
4	System description	12
4.1	Functional description	12
4.2	Measuring principle	13
4.3	Status display	13
4.4	Explanation of the product safety labels	14
4.5	Scope of delivery and accessories	15
5	Transport and storage	15
6	Installation and settings on the PC	16
6.1	Install LaserDiagnosticsSoftware LDS.....	16
6.2	Set IP address of PC.....	16
7	Mounting	17
7.1	Conditions at the installation site	17
7.2	Installation in the laser system	17
7.2.1	Prepare mounting	17
7.2.2	Possible mounting positions.....	18
7.2.3	Align the device	18
7.2.4	Mount the device	19
7.3	Removal from the laser system.....	19
8	Connections	20
8.1	Overview of the connections	20
8.2	Power supply	21
8.3	Ethernet	21
9	Measuring with the LaserDiagnosticsSoftware LDS	22
9.1	Warning messages.....	22
9.2	Establish measurement readiness	23
9.3	Connect/disconnect the device to the LDS	24
9.3.1	Switch on the device and connect it to the LDS.....	24
9.3.2	Changing the IP address of a connected device	25
9.3.3	Disconnect device from the LDS and turn off	25
9.4	General information about working with the LDS.....	26
9.4.1	Enter user-defined device name.....	26
9.4.2	Open „Device control“ menu	26
9.4.3	Open a measuring mode	27
9.4.4	Enter parameters and activate	28
9.4.5	Saving options	29
9.5	Settings that apply in all measuring modes.....	30
9.5.1	Move axes	30
9.5.2	Entries for the measuring tip used	31
9.6	Device control	32
9.6.1	Settings	32
9.6.2	Advanced	34

9.7	Linescan	36
9.7.1	Search laser beam automatically.....	36
9.7.2	Adjust the measurement track manually.....	37
9.7.3	Start measurement	38
9.7.4	Display measurement results.....	38
9.8	Single planes.....	39
9.8.1	Search laser beam automatically.....	39
9.8.2	Adjust the measurement window manually.....	40
9.8.3	Measure manual caustics with the single plane measurement mode	41
9.8.4	Start measurement	43
9.8.5	Display measurement results.....	43
9.9	Monitor	44
9.9.1	Search laser beam automatically.....	44
9.9.2	Adjust the measurement window manually.....	45
9.9.3	Start measurement	46
9.9.4	Display measurement results.....	46
9.10	Determining the tool center point (TCP).....	47
9.10.1	Distance from the pinhole to the reference plane.....	47
10	Troubleshooting	48
10.1	Messages in the LaserDiagnosticsSoftware LDS during measurement	48
10.2	Connection error when using the LDS	49
10.3	Other errors.....	50
11	Maintenance and service	51
11.1	Maintenance intervals.....	51
11.2	Cleaning.....	51
11.3	Check/replace the measuring tip	51
11.4	Replace detector.....	54
11.5	Selection of the measuring tip and the detector.....	59
12	Measures for the product disposal	60
13	Declaration of conformity	61
14	Technical data	62
15	Dimensions	63
16	Appendix	65
A	GNU GPL license notice.....	65
B	Determine the speed of the measuring tip used.....	65

PRIMES - the company

PRIMES is a manufacturer of measuring devices used to analyze laser beams. These devices are employed for the diagnostics of high-power lasers ranging from CO₂-, fiber- and solid-state lasers to diode lasers. A wavelength range from infrared to near UV is covered, offering a wide variety of measuring devices to determine the following beam parameters:

- Laser power
- Beam dimensions and position of an unfocused beam
- Beam dimensions and position of a focused beam
- Beam quality factor M^2

Development, production and calibration of the measuring devices is performed at PRIMES. This guarantees optimum quality, excellent service, and a short reaction time, providing the basis for us to meet all of our customers' requirements quickly and reliably.



PRIMES GmbH
Max-Planck-Str. 2
64319 Pfungstadt
Deutschland

Tel +49 6157 9878-0
info@primes.de
www.primes.de

1 Basic safety notes

Intended use

The device has been designed exclusively for measurements in the beam of high-power lasers.

Use for any other purpose is considered as not intended and is strictly prohibited. Furthermore, intended use requires that all information, instructions, safety notes and warning messages in this operating manual are observed. The specifications given in chapter x, „Technical Data“, on page y apply. Any given limit values must be complied with.

If not used as intended, the device or the system in which the device is installed can be damaged or destroyed. In addition, there is an increased risk to health and life. Only use the device in such a way that there is no risk of injury.

This operating manual is an integral part of the device and must be kept in the immediate vicinity of the place of use, accessible to personnel at all times.

Every person who is responsible for the installation, start-up or operation of the device must have read and understood the operating manual and, in particular, the safety instructions.

If you still have questions after reading this operating manual, please contact PRIMES or your supplier for your own safety.

Observing applicable safety regulations

Observe the safety-relevant laws, guidelines, standards and regulations in the current editions published by the state, standardization organizations, professional associations, etc. In particular, observe the regulations on laser safety and comply with their requirements.

Laser radiation warning

During the measurement the laser beam is reflected from the rotating measuring tip. This produces scattered or directed reflection of the laser beam (laser class 4). Depending on the wavelength of the laser, the reflected beam is usually invisible.

To avoid injury from the reflected laser beam, no one should be in the hazardous area where the measurement is taking place. The hazardous area must be defined before operation of the FMW+.

Before switching on the laser, ensure that the measuring tip is not in the measuring range. Wear suitable gloves and move the measuring tip out of the measuring range if necessary.

During operation of the device, the laser radiation must be fully absorbed after passing through the measurement zone.

The radiation is absorbed within the FocusMonitor FMW+. The power range is limited to 1 000 W.

When working with the device, people in the hazardous area must protect themselves by taking the following protective measures.

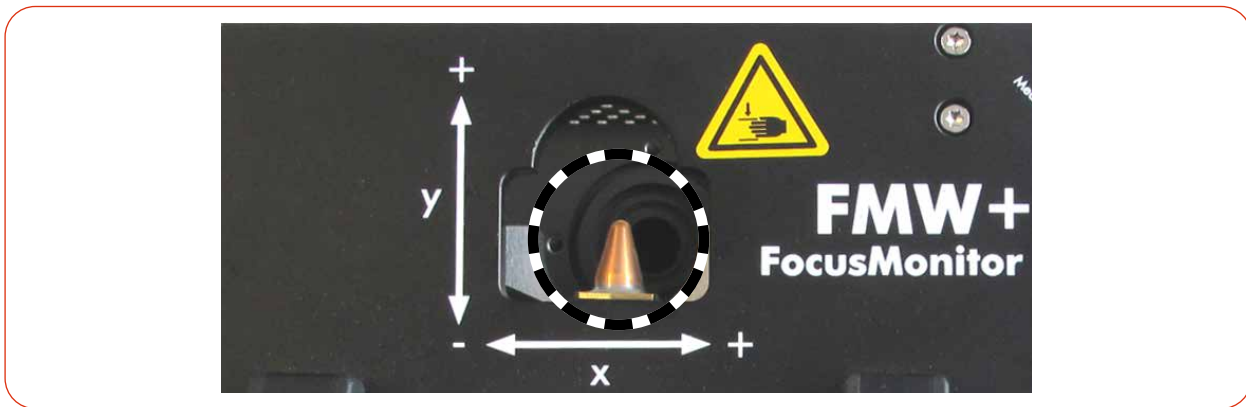

Fig. 1.1: Risk of injury due to scattered or directed reflections of the laser beam

Necessary safety measures



DANGER

Serious eye or skin injury due to laser radiation

The device measures direct laser radiation, but does not emit any radiation itself. However, during the measurement the laser beam is reflected at the rotating measuring tip. This produces scattered or directed reflection of the laser beam (laser class 4). The reflected beam is usually not visible.

- ▶ In measurement mode, a safety distance of one meter to the device must be maintained even when wearing safety goggles and safety clothing.
- ▶ Protect yourself from direct and reflected laser radiation while working with the device by taking the following measures:

- Never leave the device unattended when taking measurements.
- Wear **safety goggles** adapted to the power, power density, laser wavelength and operating mode of the laser beam source in use.
- Wear suitable **protective clothing** or **protective gloves** if necessary.
- If possible, also protect yourself from direct laser radiation and scattered radiation by using separating protective devices that block or attenuate the radiation.
- If the device is moved from its aligned position, increased scattered or directed reflection of the laser beam occurs during measuring operation. Mount the device in such a way that it cannot be moved unintentionally, i.e. by bumping or pulling the cables.
- Install safety switches or emergency safety mechanisms that allow the laser to be switched off immediately.
- Use suitable beam guidance and beam absorber elements which do not emit any hazardous substances when irradiated.

Employing qualified personnel

The device may only be operated by qualified personnel. The qualified personnel must have been instructed in the installation and operation of the device and must have a basic understanding of working with high-power lasers, beam guiding systems and focusing units.

Conversions and modifications

The device may not be modified in terms of design or safety without the explicit consent of the manufacturer. The same applies to unauthorized opening, dismantling and repair. The removal of covers is only permitted within the scope of the intended use.

Liability disclaimer

Manufacturer and distributor exclude any liability for damages and injuries which are direct or indirect consequences of using the device not as intended or modifying the device or the associated software without authorization

2 Icons and conventions

Warning messages

The following icons and signal words indicate possible residual risks in the form of warnings:

 **DANGER**

Means that death or serious physical injuries **will** occur if necessary safety precautions are not taken.

 **WARNING**

Means that death or serious physical injuries **may** occur if necessary safety precautions are not taken.

 **CAUTION**

Means that minor physical injury **may** occur if necessary safety precautions are not taken.

NOTICE

Means that property damage **may** occur if necessary safety precautions are not taken.

Product safety labels

The following icons are used on the device itself to indicate imperatives and possible dangers:



Read and understand the operating manual before using the device!



Labeling according to WEEE directive:

The device must not be disposed of with household waste, but in a separate WEEE collection in an environmentally friendly way.



Hand injuries warning



General warning sign



Do not touch!

Further icons and conventions in this operating manual



Here you will find useful information and helpful tips.



Indicates a single instruction.

If several of these instructions appear one below the other, the order in which they are executed is irrelevant or they represent alternative courses of action.

1.

A numbered list identifies a sequence of instructions that must be executed in the specified order.

2.

...



Indicates the result of an action to explain processes that take place in the background.



Indicates an observation prompt to draw attention to visible feedback from the device or the software.

Observation prompts make it easier to check whether an instruction was executed successfully. Often they also guide to the next instruction.



Points to a control element that is to be pressed / clicked.



Points to an element described in the text (for example an input field).

3 About this operating manual

This manual describes the installation and operation of the FocusMonitor FMW+ and how to perform measurements with the LaserDiagnosticsSoftware LDS version 3.0 or higher.

In this operating manual, the abbreviations FMW+ and LDS are used.

For measurement operation with a PC, the LDS must be installed on the PC. The LDS included in the delivery. PRIMES will also be happy to provide you with a current download link.

For this purpose, contact your sales partner or send an e-mail to: support@primes.de

The software description includes a brief introduction on using the device for measurements. For a detailed description of the software installation, file management and evaluation of the measurement data, please refer to the separate instructions for the LDS.



This operating manual describes the software version valid at the time of printing. Since the LDS is subject to continuous development, the supplied data medium may have a newer version number.

4 System description

4.1 Functional description

The FMW+ measures the beam properties of focused laser beams. In addition to the geometric dimensions of the focused laser beam, the focus position in space, the beam parameter product as well as the beam quality factor M^2 are determined.

The laser beam is scanned along the x-axis with a rotating measuring tip. The integrated horizontal carrier is used to move the measuring tip along the y-axis so that the beam properties of the focused laser beam can be measured in the plane.

The FMW+ does not have its own z-axis. The z-axis of the laser system must therefore be used for caustic measurements.

The FMW+ can be used to measure both NIR and CO₂ beams up to 1,000 W laser power. The device has an internal absorber that is not actively cooled. The maximum capacity is 90 kJ.

The maximum 8 x 8 mm measurement window can be scanned with a resolution of up to 1 024 x 1 024 pixels.

The FMW+ works with the PRIMES LDS and is equipped with an Ethernet interface for fast and secure data exchange.

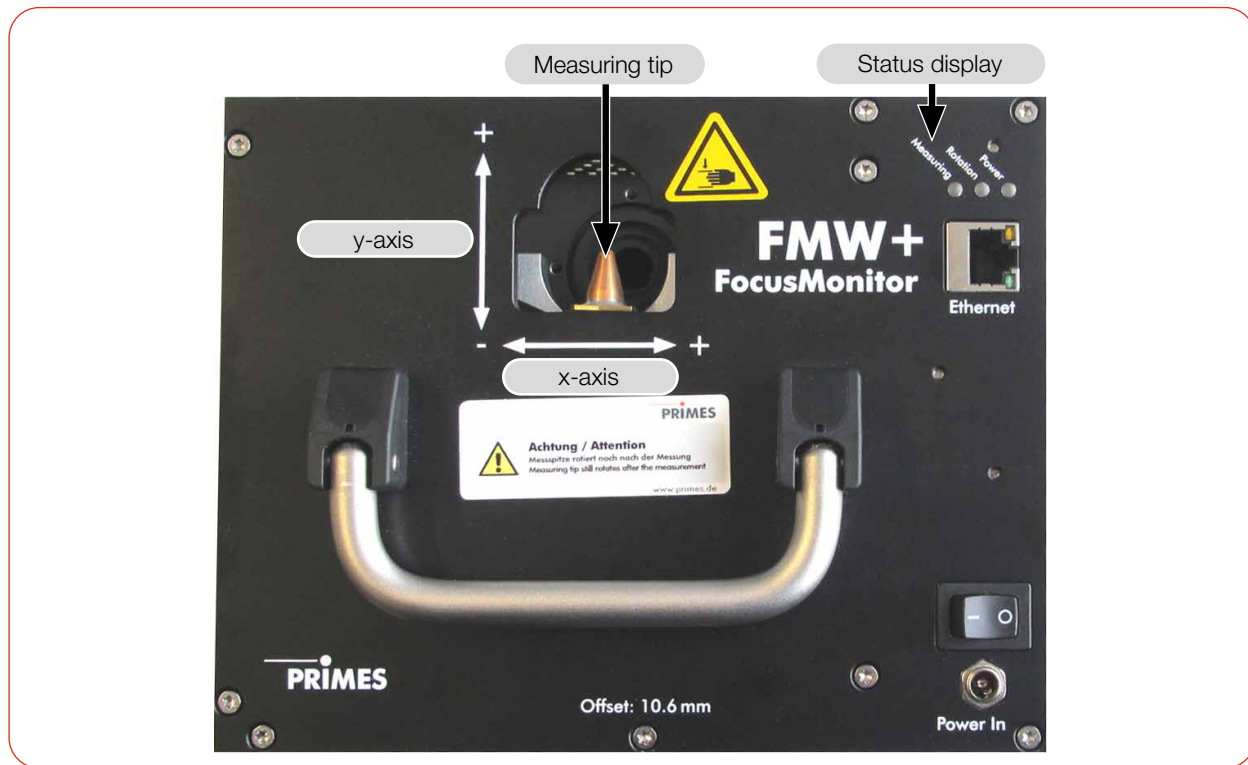

Fig. 4.1: Main components FMW+

4.2 Measuring principle

The FMW+ is an opto-mechanically scanning measuring system.

The laser beam is scanned using a specialized measuring tip. A small pin hole (typical diameter: 25 μm) in the measuring tip samples a small part of the laser beam. The sampled part of the laser beam is guided onto a detector element

The detector is selected depending on the wavelength of the laser radiation to be measured. In this way, different laser beam sources and systems can be measured by optimally selecting the measuring tip and the associated detector.

The high angular velocity of the rotating measuring tip allows the analysis of high power densities.

Due to the dynamics of the analog-to-digital converters used, a very good signal-to-noise ratio is achieved. Very low intensities as well as high peak intensities are recorded with equal precision.

4.3 Status display

The optical display consists of three LEDs, which use different colors to show different states of the FMW+.

	Color	Device status	Meaning
	White	Power	The supply voltage is connected
	Yellow	Rotation	The measuring tip is rotating
	Red	Measuring	The measuring tip is rotating and the y-axis is moving. The measurement is in progress.

Tab. 4.1: States of status display

4.4 Explanation of the product safety labels

A potential hazard area for hand injuries is marked with a symbol “Hand injuries warning” on the device.

Warning of hand injuries due to the rotating measuring tip

The rotating disk with the mounted measuring tip rotates at high speed during measuring operation. Even after a measurement or after switching off the device, the rotational disc will continue to rotate for a certain period of time.

To avoid hand injury, do not reach into the device aperture when the measuring tip is rotating.

If the rotating measuring tip hits an obstacle, the measuring tip will be damaged. In this case, the device must be sent in for service. Therefore, no objects may be held in the beam path of the device.

After switching off the rotation or the device, wait for the measuring tip to come to a standstill. Observe the „Rotation“ status display, see chapter 4.3 „Status display“ on page 13).

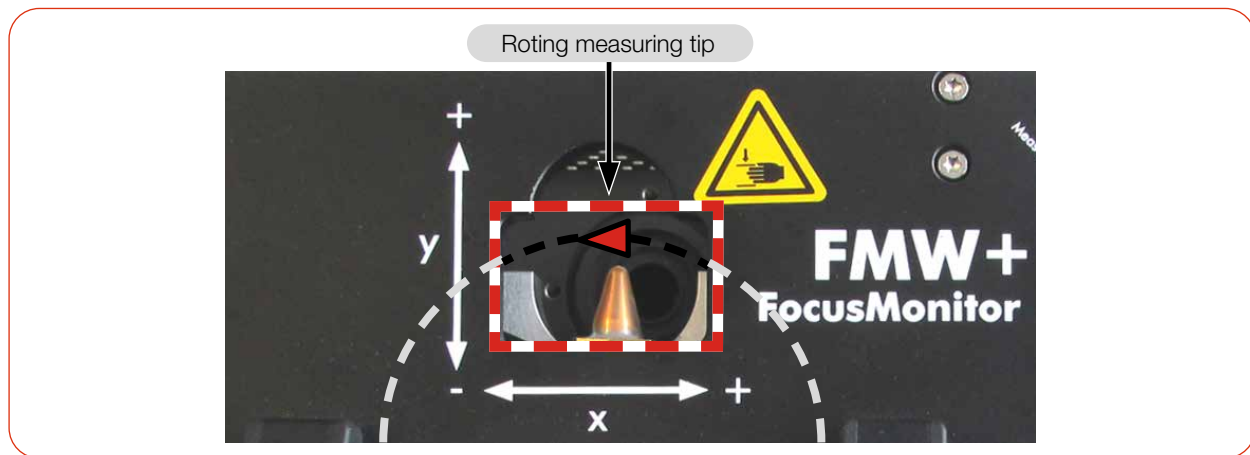

Fig. 4.2: Risk of injury due to a rotating measuring tip

Warning of hand injuries in the device openings

Rotating gears and the horizontal carrier are located in the device opening. Do not reach into the movement range of the carrier.



Fig. 4.3: Risk of injury due to a rotating parts

4.5 Scope of delivery and accessories

The following parts are included in the scope of delivery:

- FMW+
- PRIMES power supply
- Power cable
- Patch cable Cat.5e, Cross-Over, 5 m
- Patch cable Cat.5e, 5 m
- PRIMES USB flash drive (PDF of operating manual, software, etc.)
- Operating manual FMW+
- Operating manual LDS

The following accessories are available:

- Transport and storage case
- Measuring tip in a membrane box
- Detectors with box and screwdriver for mounting

5 Transport and storage

NOTICE

Damage/Destruction of the device

The device's axes and carriers may be damaged if the device is subjected to hard shocks.

- ▶ Handle the device carefully when transporting or installing it.

NOTICE

Damage/Destruction of the device

Imbalance of the rotational disc can damage the device.

- ▶ Never operate the device without the measuring tip.

Remove measuring tip to avoid contamination

It is recommended to remove the measuring tip from the FMW+ and place it in the supplied membrane box.

- ▶ Remove the measuring tip according to chapter 11.3 „Check/replace the measuring tip“ on page 51.

6 Installation and settings on the PC

6.1 Install LaserDiagnosticsSoftware LDS



The basic version of LDS is included with the device. PRIMES will also be happy to provide you with a link to download the current version. Please contact your sales partner or contact us by email: support@primes.de

1. Please ensure:
 - System requirements are met.
 - You have administrator rights.
2. Close all programs on your PC.
3. Insert the PRIMES thumb drive into your PC and open the directory. In the standard configuration, Windows automatically opens the removable storage device.
4. Double-click the LDS_Setup.exe file to start the installation.
5. Follow the instructions on the screen.
 - ➔ If no other location is specified, then the main program **LDS.exe** will be copied to the directory **C:\Programs\Primes\LaserDiagnosticsSoftware**.

System requirements:

- Intel Pentium Core i3 or better
- Windows 10 (64-bit version)
- At least 4 GB RAM; 8 GB RAM recommended
- Display resolution: Full HD (1 920 x 1 080) at 100 % scaling
- An Ethernet port for connecting the measuring device

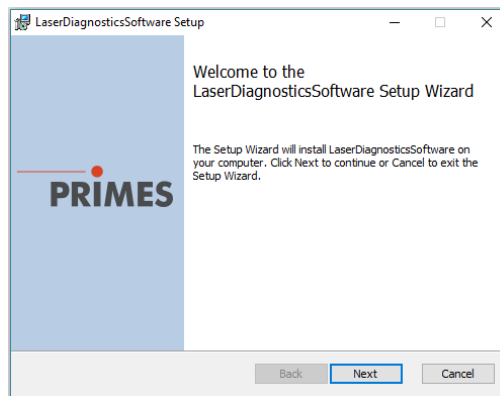

6.2 Set IP address of PC



The PC must be in the same IP address range as the PRIMES device.

Choose one of the following options to establish a connection between the PRIMES device and the PC. The IP address of the PRIMES device can only be changed once this connection has been established (see chapter 9.3.2 „Changing the IP address of a connected device“ on page 25).

Integration of a PRIMES device into a network

Within the PRIMES device, the option DHCP (Dynamic Host Configuration Protocol) is activated by default. The device obtains its IP address from the DHCP server.

Direct connection of a PRIMES device to a PC

In **Windows > Control panel > Network and Sharing Center**, assign an IP address to your PC that is in the same address range as the PRIMES device (e.g. 192.168.116.xyz). The first three number blocks must be identical, the last number block can be freely selected. The IP address should be entered by a system administrator.

The IP address of your PRIMES device can be found on the identification label.

7 Mounting

7.1 Conditions at the installation site

- The device must not be operated in a condensing atmosphere.
- The ambient air must be free of gases and aerosols that interfere with the laser radiation (e.g. organic solvents, cigarette smoke, sulfur hexafluoride).
- Protect the device from splashes of water and dust.
- Operate the device in closed rooms only.

7.2 Installation in the laser system

7.2.1 Prepare mounting

Mounting preparation

To prevent damage during transportation, the measuring tip is removed when delivered. It is installed with the curved side facing the laser beam.

- ▶ Mount the measuring tip according to chapter 11.3 „Check/replace the measuring tip“ on page 51.

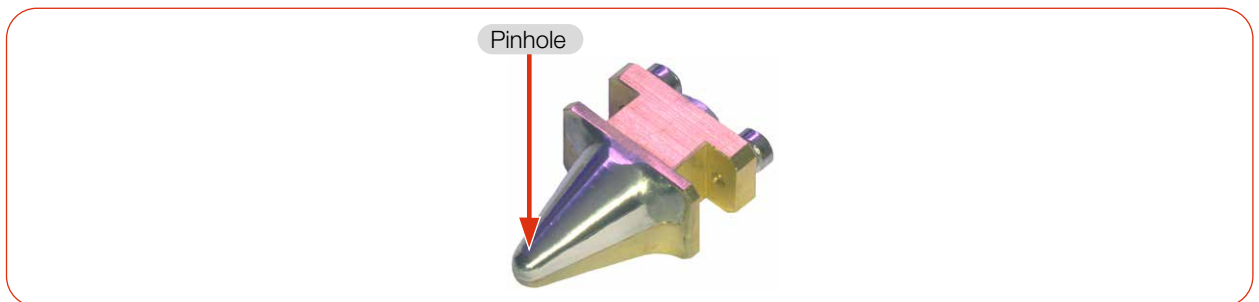

Fig. 7.1: Measuring tip

1. Switch off the laser beam.
2. Ensure that moving parts, e.g. robot arms, etc. are at a standstill and that they cannot be set in motion unintentionally.
3. Check the space available before installing the device, especially the required space for the connection cables and hoses.

7.2.2 Possible mounting positions

The FMW+ is designed for vertical beam incidence from above

7.2.3 Align the device



Only use a pilot laser for alignment.



DANGER

Serious eye or skin injury due to laser radiation

If the laser beam hits the stationary measuring tip located in the measurement aperture, scattered or directed reflection of the laser beam occurs (laser class 4).

- ▶ Wear suitable gloves and move the measuring tip out of the measurement aperture.



CAUTION

Risk of injury caused by rotating or moving parts

The hand or fingers can be crushed in the travel range of the horizontal and vertical carrier. There is a risk of injury due to the rotating measuring tip.

- ▶ Do not reach into the device openings.
- ▶ Do not reach into the measuring range of the device or hold objects into it.
- ▶ Only align the device while the measuring tip is stationary.

For the FMW+, a vertical beam incidence is required with respect to the x-y plane.

1. Position the device in the x and y directions so that the pilot laser beam hits the geometric center of the semicircle in the entrance opening.
2. Move the system to the lower measuring position of the z-axis.

Position of the laser beam

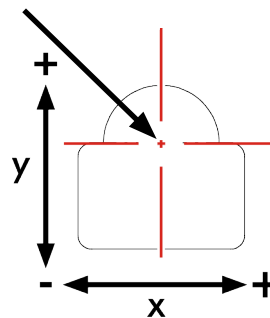

7.2.4 Mount the device



DANGER

Serious eye or skin injury due to laser radiation

If the device is moved from its aligned position, increased scattered or directed reflection of the laser beam occurs during measuring operation (laser class 4).

- ▶ Mount the device so that it cannot be moved by an unintentional contact or cables being pulled accidentally.

There are three M5 threaded holes on the bottom of the housing for fastening.

Fasten the device with 3 screws. The total length of the screws depends on the dimensions of the customer's support bracket.

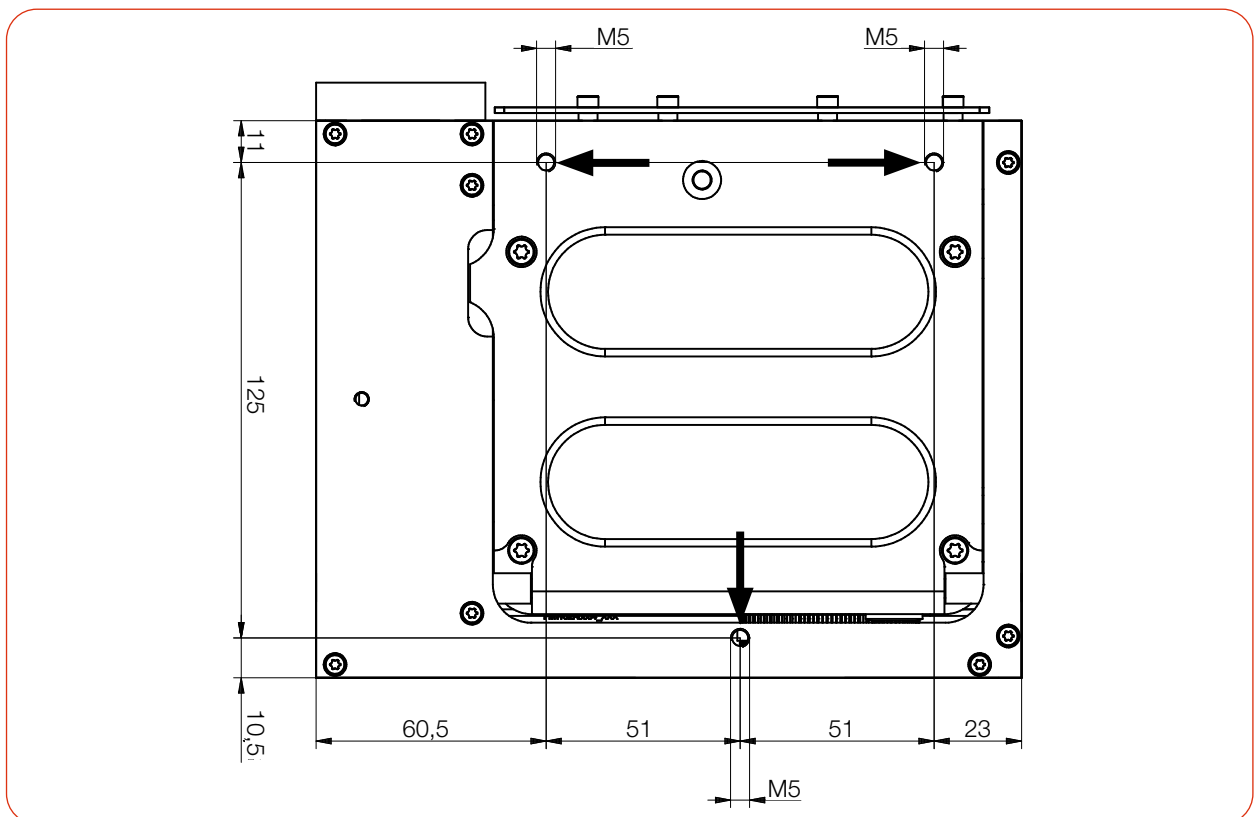

Fig. 7.2: Mounting threads on the bottom of the FMW+

7.3 Removal from the laser system

1. Switch off the laser beam.
2. Ensure that moving parts, e.g. robot arms, etc. are at a standstill and that they cannot be set in motion unintentionally.
3. Switch off the device.
4. Disconnect all connections.
5. Unscrew the fastening screws.
6. Remove the device from the laser system.

8 Connections

8.1 Overview of the connections



Establish all electrical connections and switch on the device before starting the LDS.

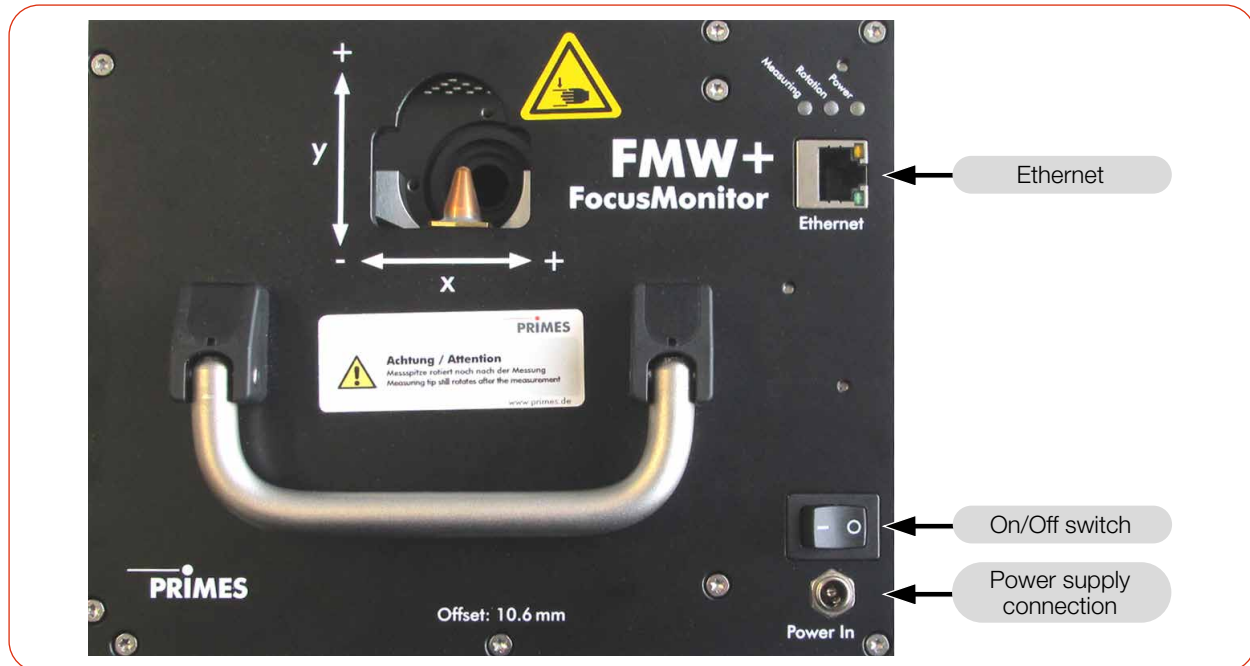

Fig. 8.1: FMW+ connections

8.2 Power supply

The device requires a voltage supply of $+24\text{ V} \pm 5\%$ (DC) for operation.

A suitable power supply is included in the scope of delivery.



Only use the provided PRIMES power supply and connection lines.

8.3 Ethernet

Data between the FMW+ and PC is transmitted via Ethernet. Connect the FM+ to the PC via a crossover cable or to the network via a patch cable.

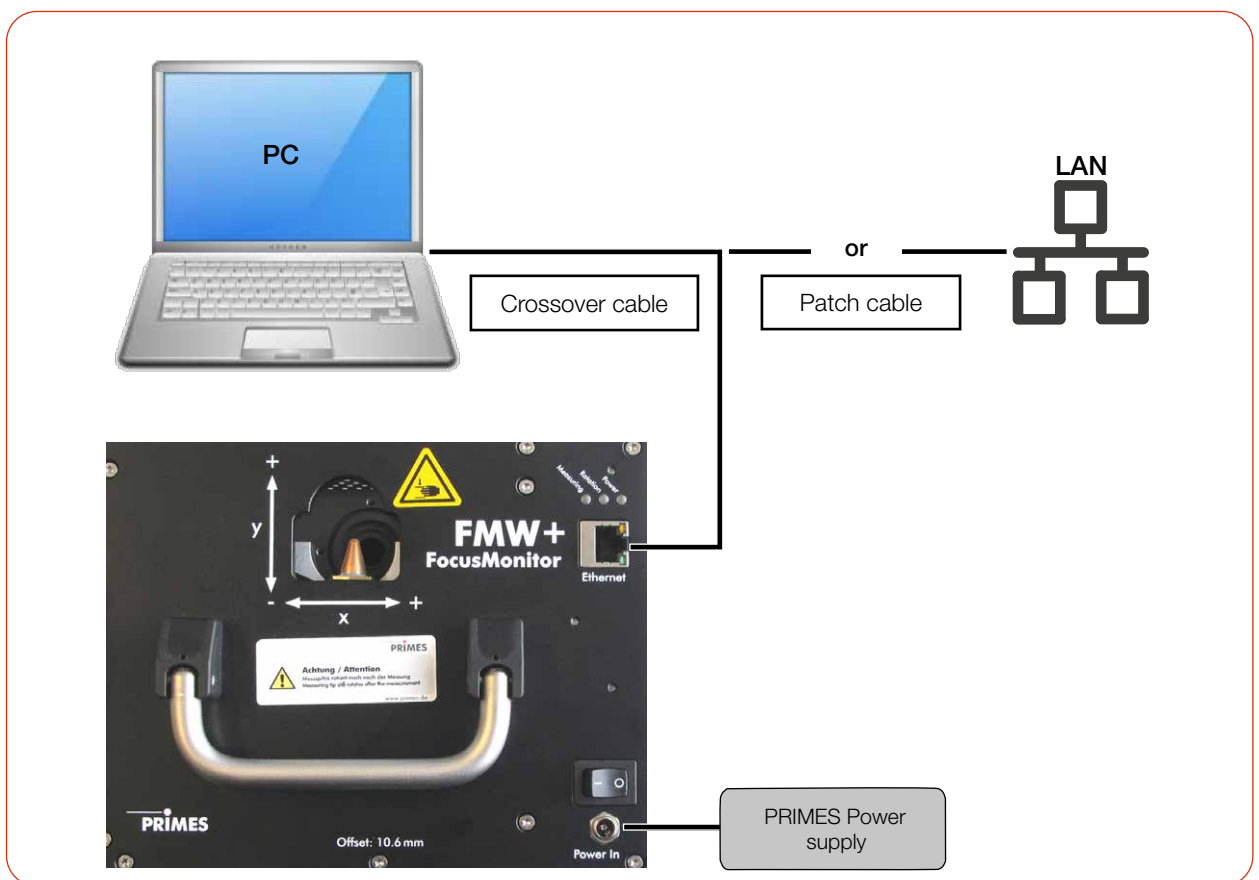

Fig. 8.2: Connect the FMW+

9 Measuring with the LaserDiagnosticsSoftware LDS

This chapter describes measurements with the LDS. For a detailed description of the software installation, file management and evaluation of the measured data, please refer to the separate operating manual "LDS".

9.1 Warning messages



DANGER

Serious eye or skin injury due to laser radiation

Depending on the measuring principle used, the laser beam is reflected at the measuring tip (laser class 4). The reflected beam is usually not visible.

- ▶ Please wear safety goggles adapted to the power, power density, laser wavelength and operating mode of the laser beam source in use.
- ▶ Wear suitable protective clothing and protective gloves.
- ▶ Protect yourself from laser radiation by separating protective devices (e.g. by using appropriate shielding).
- ▶ During measurements, a safety distance of one meter to the FMW+ must be maintained even when wearing safety goggles and safety clothing.



DANGER

Serious eye or skin injury due to laser radiation

If the device is moved from its aligned position, increased scattered or directed reflection of the laser beam can occur during measuring operation (laser class 4).

- ▶ Mount the device so that it cannot be moved by an unintentional contact or cables being pulled accidentally.



CAUTION

Risk of injury caused due to the rotating measuring tip

The measuring tip of the FMW+ rotates at high speed during measurements. Even after the rotation or the device has been turned off, the measuring tip will continue to rotate for a certain period of time. If the rotating measuring tip hits an obstacle, the device must be sent in for service to readjust the measuring tip.

- ▶ Do not reach into or hold any objects into the beam entrance of the device.
- ▶ Wait for the measuring tip to come to a standstill (observe the „Rotation“ status display)

 **CAUTION****Risk of injury caused due to the rotating or moving parts**

The hand or fingers can be crushed in the device openings by rotating gears and the carrier.

- ▶ Do not reach into device openings
- ▶ Do not reach into or hold any objects into the beam entrance of the device.

NOTICE**Damage/Destruction of the absorber**

An acoustic warning signal is triggered when the temperature of the absorber reaches 60 °C.

- ▶ In the event of the alarm, switch off the laser immediately and allow the absorber to cool down!

NOTICE**Damage/Destruction of the measuring tip**

In case of very high power densities (CO₂ > 15 – 30 MW/cm²; NIR > 8 – 10 MW/cm²), plasma may be ignited on the surface of the measuring tip, which could destroy the measuring tip.

- ▶ Increase the speed according to appendix B on page 65 and purge it with inert gas, if necessary.

9.2 Establish measurement readiness

1. Check whether the mounted measuring tip and the mounted detector are suitable for your measuring task, see chapter 11.5 „Selection of the measuring tip and the detector“ on page 59.
2. Determine the required speed of the measuring tip according to appendix B on page 65.

9.3 Connect/disconnect the device to the LDS

9.3.1 Switch on the device and connect it to the LDS

1. Switch on the device.
2. Start the LDS by double-clicking on the program icon **LDS** in the start menu group or on the desktop icon.

 The start screen appears.

3. Select the operating mode **Measure**.

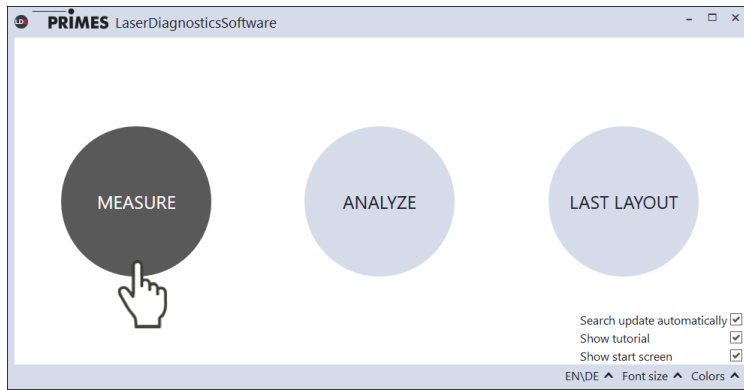

If the **Show start screen** option is disabled or the window **Connections** is closed:

- ▶ Click on the **Devices** tab and then on the **+ Connect to device** button.

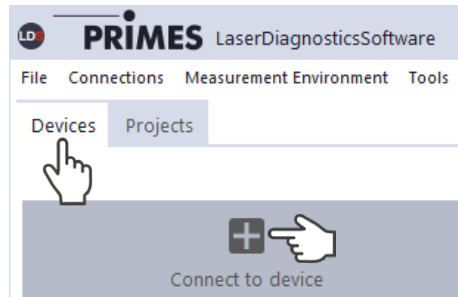

 The **Connections** window appears.

4. Click on the desired device.
5. Click on the **Connect to device** button.

If the device does not appear:

- ▶ Click on the **Search the network** button.

If the device still does not appear in the **Connections** window, see chapter 10.2 „Connection error when using the LDS“ on page 49.

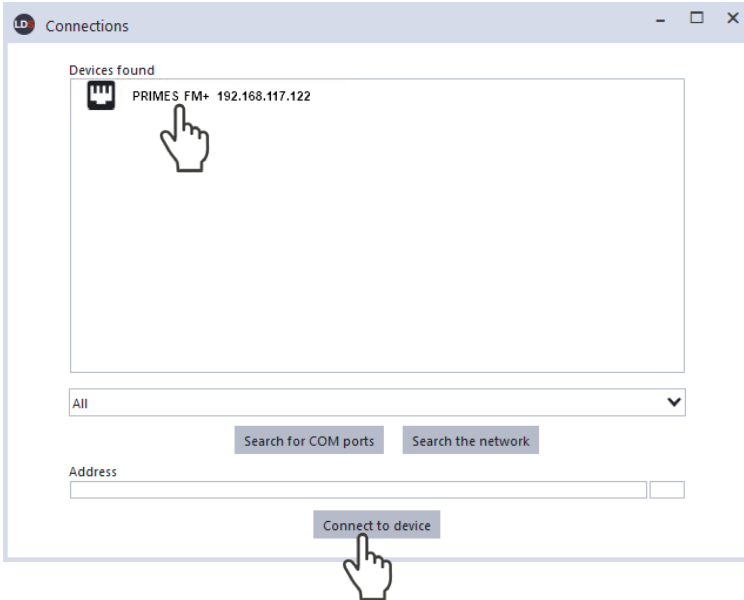

9.3.2 Changing the IP address of a connected device

Within the device a static IP address is stored and the function **Use DHCP** is activated. When establishing a connection, the device will first wait to be assigned a suitable IP address via DHCP. If this proves unsuccessful, it will revert to the static IP address.

If **Use DHCP** is disabled, the device will directly use the static IP address. As a result, the connection can be established faster.

For a connected device, both the IP address and the activation of DHCP can be changed.

Change the IP address of a device as follows:

1. Click on the **Devices** tab.
2. Right-click on the device and select the **Device settings** menu point.
3. Enter the desired IP address in the **Static IP address** input field.
4. Deactivate **Use DHCP**.
5. Confirm the entry with **OK**.

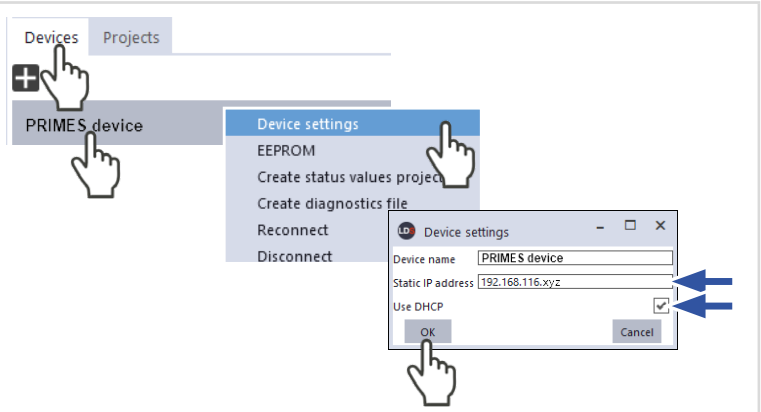

 The **Confirmation** window appears.

6. In the **Confirmation** window, place a check mark at **Acknowledge** and click **OK**.
7. Switch the device off and on again.

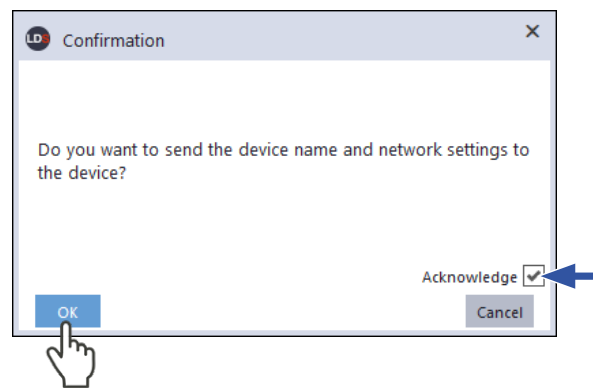

9.3.3 Disconnect device from the LDS and turn off

1. Click on the **Devices** tab.
2. Right-click on the device and select the **Disconnect** menu point.
3. Switch off the device.
4. If applicable, disconnect the electrical connections.

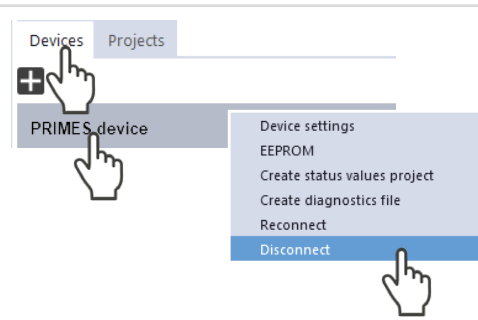

9.4 General information about working with the LDS

This chapter contains general information about the LDS, irrespective of the respective measuring task. Read this general information before turning to the following chapters on the various measurement modes.

9.4.1 Enter user-defined device name

If you want to assign a user-defined device name to a device, proceed as follows:

1. Click on the **Devices** tab.
2. Right-click on the device and select the **Device settings** menu point.
3. Enter the desired device name in the **Device name** input field (max. 18 characters).
4. In the **Device settings** window, confirm the entry with **OK**.

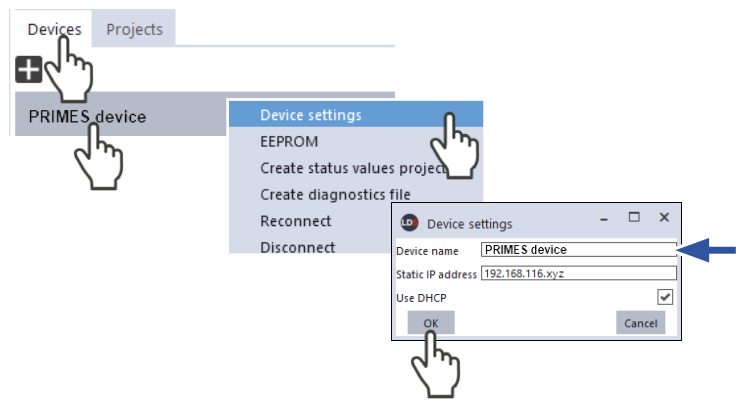

5. Place a check mark at **Acknowledge** and click **OK**.
6. Switch the device off and on again.
 - ➔ The device name is displayed in the **Connections** window.
 - ➔ After connecting, the device name is displayed in the **Devices** tab.

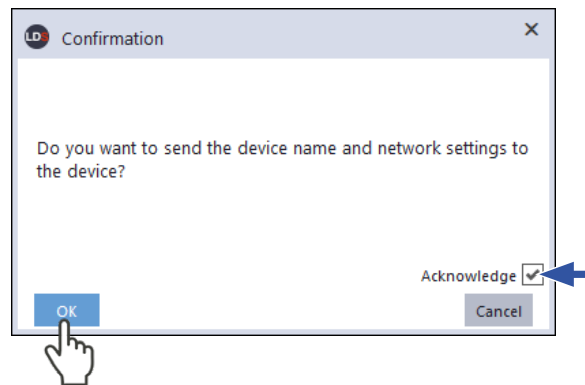

9.4.2 Open „Device control“ menu

1. Click on the **Devices** tab.
 2. Select the device and click on the device function **Scanner** below the device name.
- 👁 The **Device control** menu with the following sections opens.
- **Measuring modes** (see chapter 9.4.3 on page 27)

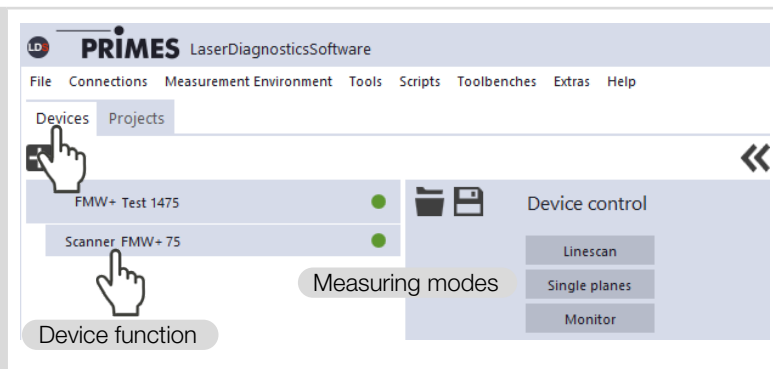

9.4.3 Open a measuring mode

The desired measuring mode is selected in the **Device control** menu. The following measuring modes are available:

- **Linescan** (see chapter 9.7 „Linescan“ on page 36)
- **Single planes** (see chapter 9.8 „Single planes“ on page 39)
- **Monitor** (see chapter 9.9 „Monitor“ on page 44)

<p>▶ After opening the Device control menu, click the button of the desired measuring mode, for example Single planes.</p>	<p>The screenshot shows the 'Device control' menu with three options: 'Linescan', 'Single planes', and 'Monitor'. A hand icon points to the 'Single planes' button.</p>
<p>👁️ A drop-down list for changing the measuring mode appears in the upper area of the Device control menu.</p> <p>Change measuring mode:</p> <ol style="list-style-type: none"> 1. Click on the button to open the drop-down list. 2. Select measuring mode. 	<p>A close-up of the 'Device control' menu showing a drop-down list with three items: 'Single planes', 'Linescan', and 'Monitor'. A hand icon points to the 'Single planes' item.</p>
<p>👁️ After selecting the measuring mode, the corresponding toolbench is opened.</p>	<p>The screenshot shows the 'Linescan' toolbench interface. It includes a 'Recommended tools' dropdown, a toolbar with various icons, and a main display area showing a 'Plane Analysis: Scanner FMW+ 475' plot. The plot shows 'Amplitude in cts' on the y-axis and 'Cross section x' on the x-axis. A color scale for amplitude is visible on the right, ranging from 0 to 461. Below the plot, there are 'Statistics for selected range only' and a 'Range' input field set to 0 to 628.</p>
<p>If the toolbench has been closed, re-open it by clicking the Open measurement toolbench button.</p>	<p>The screenshot shows the 'Device control' menu with a 'Measuring mode' dropdown menu. Below the dropdown is a button labeled 'Open measurement toolbench'. A hand icon points to this button.</p>

9.4.4 Enter parameters and activate

Be aware when settings are made in one measuring mode, some options are also available in other modes as well.

For example, if you enter a parameter in the **Single planes** mode, it will automatically be applied to all other measuring modes that use this same parameter.

Transfer an entered parameter value with the Enter key:

1. Enter the desired value in the input field.
- 👁 The background color of the input field changes to blue.
2. Confirm the entry by pressing the Enter key.
- 👁 The field returns to its original background color.

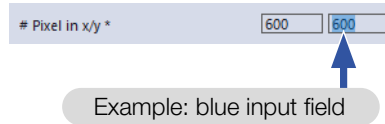



9.4.5 Saving options

The LDS offers (up to) three different options for saving. They differ by the storage location and the selection of the data to be saved.

When saving/loading a configuration, note that the command is called in a certain measurement mode, but the saved/loaded data set also includes the settings of the other measurement modes.

Save data with asterisk (*) to a file / load from a file:

All data marked with an asterisk in the **Device control** menu can be saved to a preset file with the extension **.pre** on the PC.

- ▶ To save a configuration, click on the icon .
- ▶ To load a configuration click on the icon .

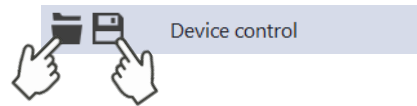

Save data with an asterisk (*) in the EEPROM of the device:

All options marked with an asterisk in the **Device control** menu can be saved in the EEPROM in the device.

In this case, the settings will be retained even if the device is switched off or disconnected from the power supply.

1. Click on the **Advanced** tab.
2. Click on the **Save device settings** button.

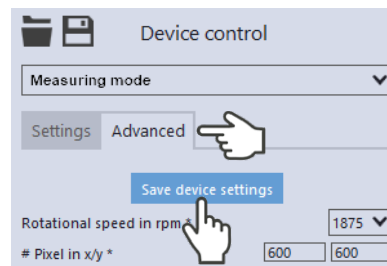

Save all settings in the LDS:

With these buttons you can save or load all settings of the **Device control** menu. The storage is made device-related in the local installation of the LDS.

1. Click on the **Settings** tab.
2. Use one of the following options:
 - ▶ Click the **Save current parameters** button to save the settings of the connected device.
 - ▶ Click on the **Load last parameters** button to load the last saved settings.

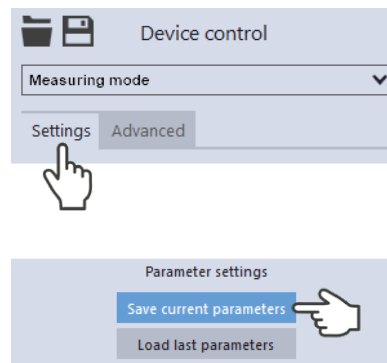

9.5 Settings that apply in all measuring modes

9.5.1 Move axes

In all measuring modes, the measuring tip can be moved to a defined y-position.

1. Click in the device **control > Advanced**.
2. Click on the arrow to open the drop-down list.

Use one of the following options:

- ▶ Enter a value in the parameter field and confirm the entry with the Enter button.
 - ▶ Use the slider below the input field.
3. Click on the button **Move to y position**.

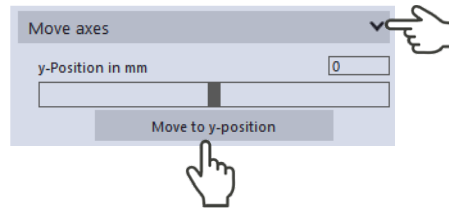
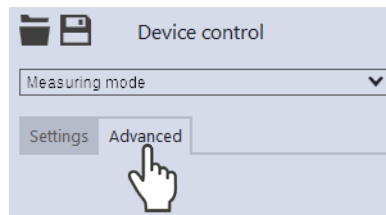

👁 The **Confirmation** window appears.

4. Switch off the laser if necessary.
 5. Check the **Acknowledge** box and click **OK**.
- ➔ The measuring tip is moved to the entered y-position.

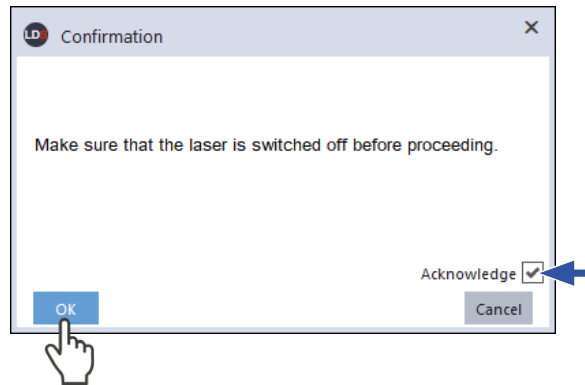

9.5.2 Entries for the measuring tip used

For traceability of the measurements performed with a specific measuring tip, the specifications of the measuring tip used can be entered into the LDS.

The specifications are indicated on the packaging of the measuring tip. Missing entries have no effect on the measurements performed.

1. After opening the **Device Control** menu, click the **Advanced** button.
2. Select the **Type** of measuring tip used from the drop-down list.
3. Enter the serial number **S/N** of the measuring tip used.
4. Enter the **Sensitivity in cts/(MW/cm²)** of the measuring tip used.
5. Enter the **Pinhole diameter in μm** of the measuring tip used.
6. Click the **Save device parameters** button.

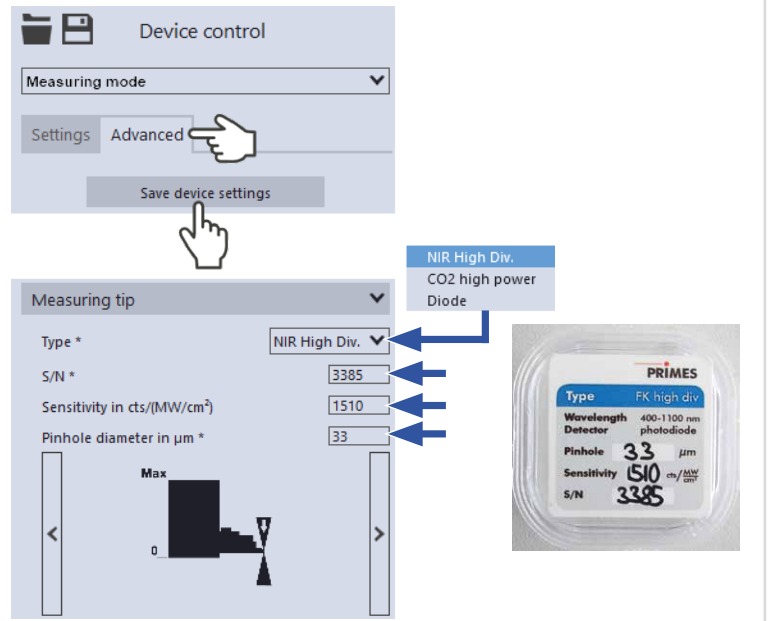

9.6 Device control

9.6.1 Settings

The options listed below in alphabetical order are not available in all measuring modes.

1. Click on the **Settings** tab.
 2. Enter the options according to the explanations in the following table.
- ▶ Data with (*) can be saved, see chapter 9.4.5 „Saving options“ on page 29.



Option	Explanation
# Pixel in x	The number of pixels determines the resolution of the measurement. Use one of the following options: <ul style="list-style-type: none"> ▶ Enter a value in the input field. ▶ Use the slider below the input field.
autom. Gain	When using a CO ₂ detector, this option is not available and will not be displayed. If this option is enabled, the gain is set automatically. <ul style="list-style-type: none"> ▶ Set the check mark to enable the option.
autom. Measurement window	If this option is enabled, then the measurement window size will be set automatically. <ul style="list-style-type: none"> ▶ Set the check mark to enable the option.
Find beam	This option enables an automatic beam search with an automated measuring window size and measurement. The laser beam is automatically searched for in the entire measuring range. Measurement window size and gain are set automatically. The measured plane is then displayed in the graphic display. <ul style="list-style-type: none"> ▶ Click on the button to start the beam search. Note that the determined measurement data will not be saved in the project tree of the Projects tab.
Gain in dB	When using a CO ₂ detector, this option is not available and will not be displayed. If the autom. Gain option is disabled, the gain can be set manually. The option can be used to control the sensitivity of the detector. Use one of the following options: <ul style="list-style-type: none"> ▶ Enter a value in the input field. ▶ Use the slider below the input field.
Interval between measurements in s *	Enter the pause between the single plane measurements of the time series. This is the pause between the end of one measurement and the start of the next.
Line center in mm	Use one of the following options to adjust the position of the measuring line: <ul style="list-style-type: none"> ▶ Enter the x-/y-position of the line center in the corresponding input fields. ▶ Position the mouse pointer within the measurement window. Then drag while holding down the right mouse button.

Line width in mm	<p>Use one of the following options to adjust the line width (length) and position:</p> <ul style="list-style-type: none"> ▶ Enter the width (length) of the line. ▶ Position the mouse pointer at any point within the measurement area and drag while holding down the left mouse button. Keep the mouse button pressed until the length of the measuring line meets your requirements.
Load last parameters	<ul style="list-style-type: none"> ▶ Click this button to load the last saved device configuration.
Manual z-Position in mm	<p>This option defines the position of the next measurement on the z-axis (see chapter 9.8.3 „Measure manual caustics with the single plane measurement mode“ on page 41).</p> <ul style="list-style-type: none"> ▶ Set the check mark at Deactivate z-axis. ▶ Enter the Manual z-position in mm.
Measurement duration in s	<ul style="list-style-type: none"> ▶ Enter the duration of the measurement in s.
nominal power P in W *	<p>To calculate the power density, the laser power used must be entered. Otherwise, the measured amplitudes are given directly in counts.</p> <ul style="list-style-type: none"> ▶ Enter the nominal laser power used during measurement.
Number of measurements *	<ul style="list-style-type: none"> ▶ Enter the desired number of single plane measurements of the time series.
Parameter settings	<p>All settings in the Device control menu can be individually saved for each device. The settings are saved to the local installation of the LDS.</p> <p>This and other options for saving/loading configurations are described in chapter 9.4.5 „Saving options“ on page 29.</p>
Position in mm	<p>Use one of the following options to adjust the position of the measurement window:</p> <ul style="list-style-type: none"> ▶ Enter the x-/y-position in the corresponding input fields. ▶ Position the mouse pointer within the measurement window. Then drag while holding down the right mouse button.
Reset measurement window	<ul style="list-style-type: none"> ▶ Click this button to maximize the measurement window and simultaneously center it in the measurement range.
Save current parameters	<ul style="list-style-type: none"> ▶ Click this button to save all current settings of the connected device.
Time series	<p>A time series consists of several single plane measurements with the same settings.</p>
Window size in mm	<p>If the autom. Measurement window option is disabled, the size of the measurement window can be set manually. Use one of the following options:</p> <ul style="list-style-type: none"> ▶ Enter the length and width in the corresponding input fields. ▶ Position the mouse pointer anywhere within the measurement range and drag while holding down the left mouse button. Keep the mouse button pressed until the measurement window meets your requirements.

9.6.2 Advanced

The options listed below in alphabetical order are not available in all measuring modes.

1. Click on the **Advanced** tab.
 2. Enter the options according to the explanations in the following table.
- ▶ Data with (*) can be saved, see chapter 9.4.5 „Saving options“ on page 29.

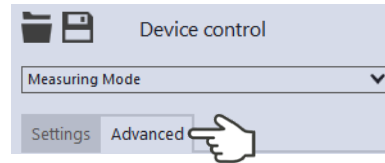

Option	Explanation
# <i>Pixel in x/y</i> *	The number of pixels determines the resolution of the measurement. Enter the resolution in x-/y-direction in the corresponding input fields.
<i>Arithmetic Average</i> *	The default algorithm for averaging the plane measurements is Arithmetic Average . Averaging over several measurements can be useful, for example, when measuring a laser with significant power fluctuations. ▶ Select an algorithm from the drop-down list: <ul style="list-style-type: none"> • Arithmetic Average: The measured values for each pixel are added together and divided by the number of planes. • Max. intensity per pixel: The values from all the measurements are compared for each pixel and only the maximum value for each one is displayed. • Max. Lines: The values from all the measurements are compared for each line (meaning the line measured by the device in x-direction) and only the maximum value for each one is displayed.
<i>Calibrated wavelength(s) in nm</i> *	The “calibrated wavelength” is the wavelength at which the device has been validated. This is stored in the device and is displayed in the LDS.
<i>Focal length of focusing optics in mm</i> *	If several planes of a caustic have been measured, the caustic fit and the entered focal length are used to calculate the raw beam diameter on the focusing optics. ▶ Enter the focal length used by the focusing optics of the laser system.
<i>Measuring tip</i>	Documentation of the measuring tip used With these options, the specifications of the measuring tip used can be entered into the LDS for documentation of the measurements performed. This option is described in chapter 9.5.2 „Entries for the measuring tip used“ on page 31.
<i>Move axes</i>	With this option, the horizontal carriers can be moved in a defined manner. There are 2 options to choose from: ▶ Enter a value in the input field. ▶ Use the slider below the input field. This option is described in chapter 9.5.2 „Move axes“ on page 39.
<i>nominal Power P in W</i> *	To calculate the power density, the laser power used must be entered. Otherwise, the measured amplitudes are given directly in counts. ▶ Enter the nominal laser power used during measurement.
<i>Number of averaged planes</i> *	With the default setting of 1 in the input field, no averaging takes place. ▶ Enter the number of plane measurements >1 for averaging
<i>Number of planes</i> *	▶ The predefined number of planes is 21. ▶ Enter the desired number of single plane measurements of the time series.

Option	Explanation
Rotational speed in rpm *	<p>The required speed of the measuring tip used must be determined according to appendix B on page 65.</p> <ul style="list-style-type: none"> ▶ Select the speed of the measuring tip from the drop-down list.
Save device settings	<p>All options marked with an asterisk in the Device control menu can be saved in the EEPROM of the device.</p> <p>These and other options for saving/loading configurations are described in chapter 9.4.5 „Saving options“ on page 29.</p>
Used wavelength in nm *	<p>To calculate the beam quality factor M^2, the used wavelength must be entered. Depending on the display in the option Calibrated wavelength(s) in nm, the used wavelength can be entered in a defined range.</p> <p>For example, with a „calibrated wavelength“ of 1 064 nm, the used wavelength can be entered from 1 000 - 1 100 nm.</p> <p>Use one of the following options to set the wavelength of the laser used:</p> <ul style="list-style-type: none"> ▶ Enter a value in the input field. ▶ Use the slider below the input field.

9.7 Linescan

In measuring mode **Linescan**, the laser beam is measured at a defined position on the y-axis over a specific period of time. The line width, line center and position on the y-axis are freely adjustable.

The measuring tip of the FM+ is moved to a fixed y-position. At this position, it measures the power density on a single measuring path with every rotation of the measurement tip.

The measurement is carried out over a defined period of time or until it is manually aborted.

9.7.1 Search laser beam automatically

1. Observe the warning messages in chapter 9.1 „Warning messages“ on page 22.
2. Click on the **Settings** tab.
3. Switch on the laser.
4. Click on the **Find beam** button.
 - ➔ The laser beam is automatically searched for in the entire measuring range. The measurement window and gain are set automatically.
- 👁 If the search is successful, the laser beam is displayed in the graphic representation.

If the beam is not displayed:

- ▶ Check for correct alignment of the device on the x-y plane according to chapter 7.2.3 „Align the device“ on page 18.
 - ▶ Check the direction of the beam entrance.
 - ▶ Adjust the gain.
 - ▶ Choose a different z-position.
 - ▶ Increase the laser power (step by step).
5. If necessary, adjust the measurement track manually according to the following. chapter 9.7.2 „Adjust the measurement track manually“ on page 37 .
 6. Start the measurement according to chapter 9.7.3 „Start measurement“ on page 38.

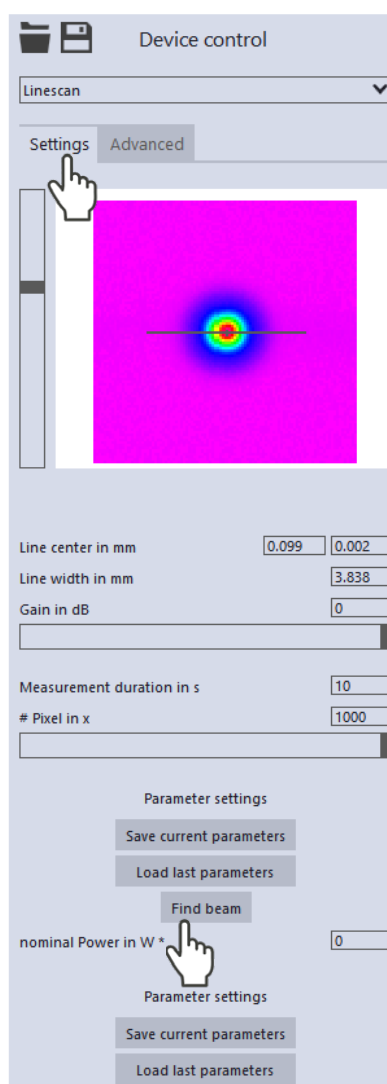

9.7.2 Adjust the measurement track manually

In a window in the upper area of the **Settings** tab, the measurement plane is displayed graphically:

- the entire measurable area (thin lines)
- the measurement track to be recorded (thick lines)
- the measuring position on the z-axis
- after performing a beam find and during the measurements, a false color view of the recorded area

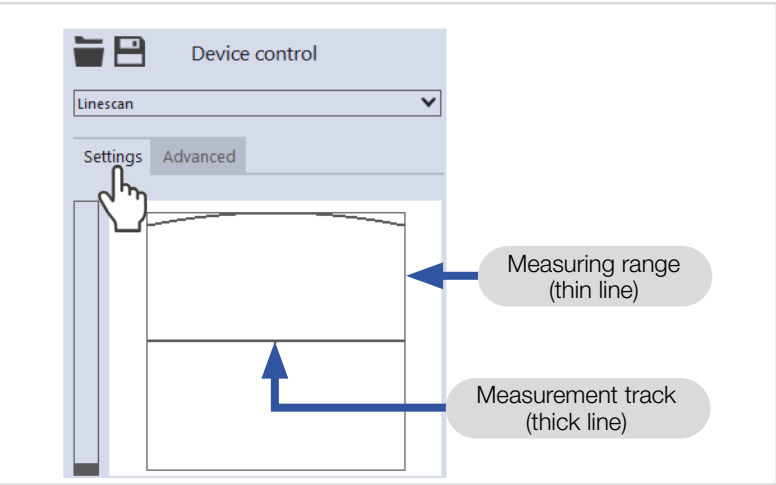

Create a measurement track:

- ▶ Position the mouse pointer anywhere within the measurement range. Drag while holding down the left mouse button. Keep the mouse button pressed until the measurement track meets your requirements.

Adjust the position:

- ▶ Enter the x-/y-position of the track center in the corresponding input fields.
- ▶ Position the mouse pointer over the measurement track. Drag while holding down the right mouse button.

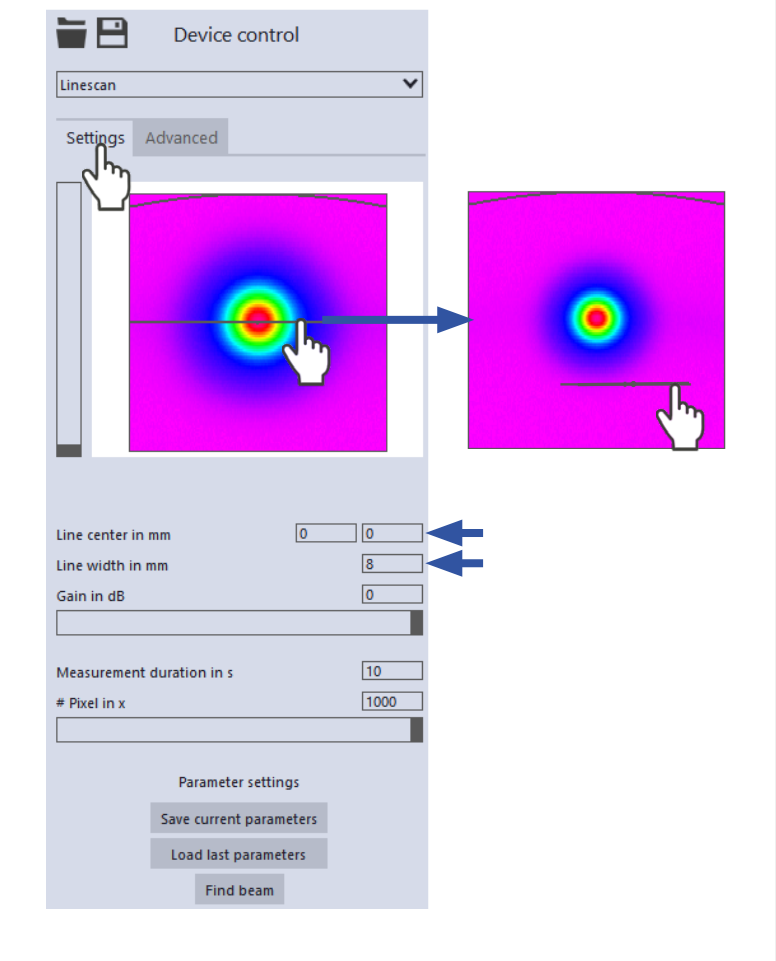

With a laser beam displayed:

- ▶ To zoom to the center of the graphic representation, first move the mouse pointer over the graphic representation until the plus/minus buttons appear. Then press the buttons.
- ▶ To zoom in on the position of the mouse pointer, position the mouse pointer anywhere within the graphic representation. Then turn the mouse wheel.
- ▶ To zoom to the size of the measuring range. Position the mouse pointer within the measuring range. Then double-click left.

9.7.3 Start measurement

1. Observe the warning messages in chapter 9.1 „Warning messages“ on page 22.
2. Click the **Start** button.
3. Switch on the laser.
 - ➔ The measurement begins.

Optional:

- ▶ Click the **Stop** button to abort the measurement.
- ▶ Click the **Stop Rotation** button to stop the rotation of the measuring tip.
- 👁️ During the measurement, the progress is shown in the following indicators:

Measurement:

While the indicator is rotating, the measurement is performed.

Measurement completed:

After successful measurement, the indicator lights up green.

4. Switch off the laser after the measurement is completed, unless you want to perform further measurements.

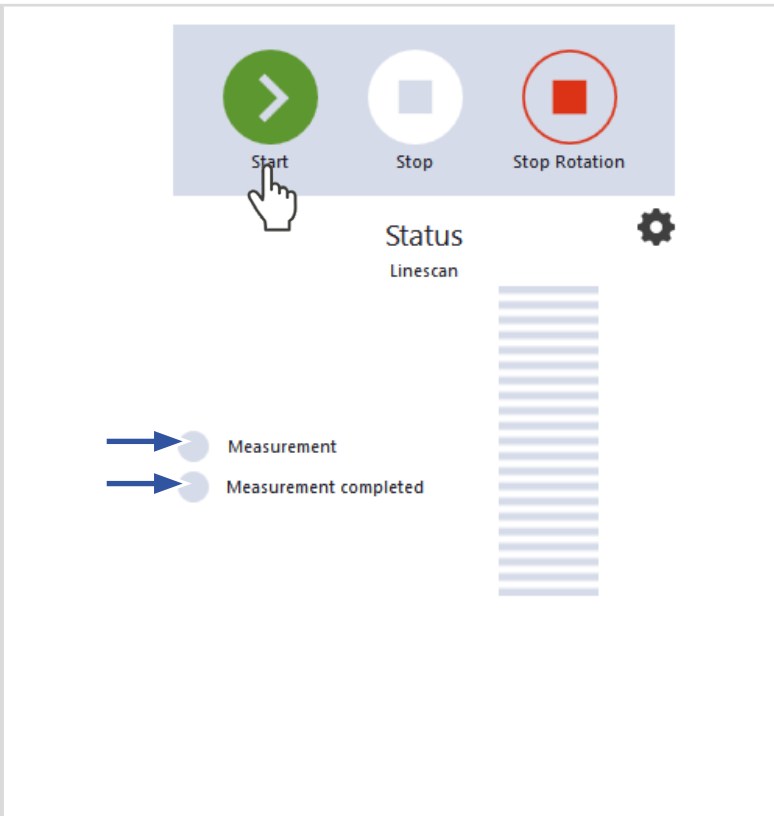

9.7.4 Display measurement results

The measurement results are displayed in the opened tool during and after the completed measurement.

- ▶ PRIMES recommends checking the quality of the results after a measurement.
 - Depending on the results, it may seem necessary to repeat the measurement with improved measurement setup or changed parameters.
- ▶ For a detailed description of the file management and evaluation of the measured data, please refer to the separate operating manual LDS.

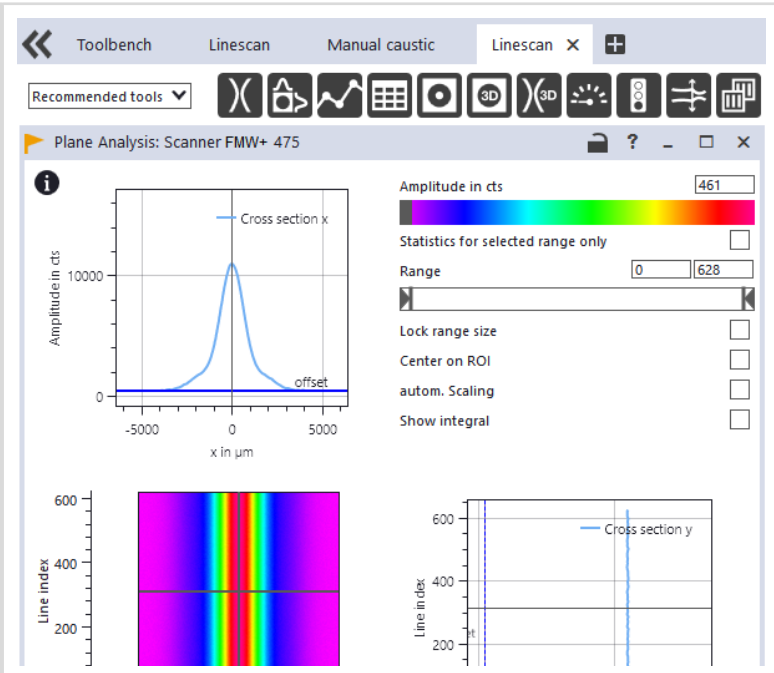

9.8 Single planes

In **single planes** measuring mode, single planes are measured at selected z-positions. Measurement window size and the gain can be set automatically or determined manually.

You can also have the software search for the laser beam automatically in the entire measurement range.

To measure a manual caustic, several planes can be measured — either individually or by means of a serial measurement.

An increment along the z-axis can be configured for this, see chapter 9.8.3 „Measure manual caustics with the single plane measurement mode“ on page 41.

The FMW+ does not have its own z-axis. The z-axis of the laser system must therefore be used for caustic measurements.

9.8.1 Search laser beam automatically

1. Observe the warning messages in chapter 9.1 „Warning messages“ on page 22.
 2. Click on the **Settings** tab.
 3. Switch on the laser.
 4. Click on the **Find beam** button.
 - ➔ The laser beam is automatically searched for in the entire measuring range. The measurement window and gain are set automatically.
- 👁️ If the search is successful, the laser beam is displayed in the graphic representation.

If the beam is not displayed:

- ▶ Check the correct alignment of the device on the x-y plane again according to chapter 7.2.3 „Align the device“ on page 18.
 - ▶ Check the direction of the beam entrance.
 - ▶ Adjust the gain.
 - ▶ Choose a different z-position.
 - ▶ Increase the laser power (in small increments).
5. If necessary, adjust the measurement window manually according to the following. chapter 9.8.2 „Adjust the measurement window manually“ on page 40 an.
 6. Start the measurement according to chapter 9.8.4 „Start measurement“ on page 43.

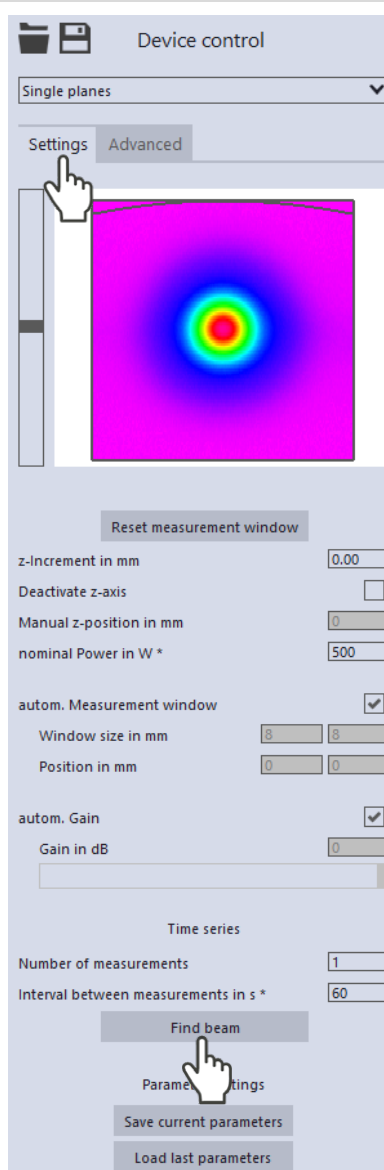

9.8.2 Adjust the measurement window manually

In a window in the upper area of the **Settings** tab, the measurement plane is displayed graphically:

- the entire measurable area (thin lines)
- the measurement window to be recorded (thick lines)
- the measuring position on the z-axis
- after performing a beam find and during the measurements, a false color view of the recorded area

Make sure that the **autom. measurement window** option is not activated. Otherwise, the manual setting may be overwritten when starting a measurement.

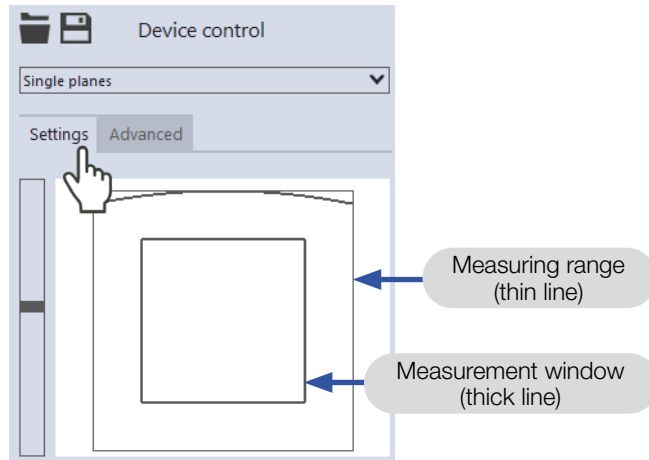

Create a measurement window:

- ▶ Position the mouse pointer anywhere within the measurement range. Drag while holding down the left mouse button. Keep the mouse button pressed until the measurement window meets your requirements.

Adjust the position:

- ▶ Enter the x-/y-position in the corresponding input fields.
- ▶ Position the mouse pointer anywhere within the measurement window. Drag while holding down the right mouse button.

With a laser beam displayed:

- ▶ To zoom to the center of the graphic representation, first move the mouse pointer over the graphic representation until the plus/minus buttons appear. Then press the buttons.
- ▶ To zoom in on the position of the mouse pointer, position the mouse pointer anywhere within the graphic representation. Then turn the mouse wheel.
- ▶ To zoom to the size of the measuring range. Position the mouse pointer within the measuring range. Then double-click left.

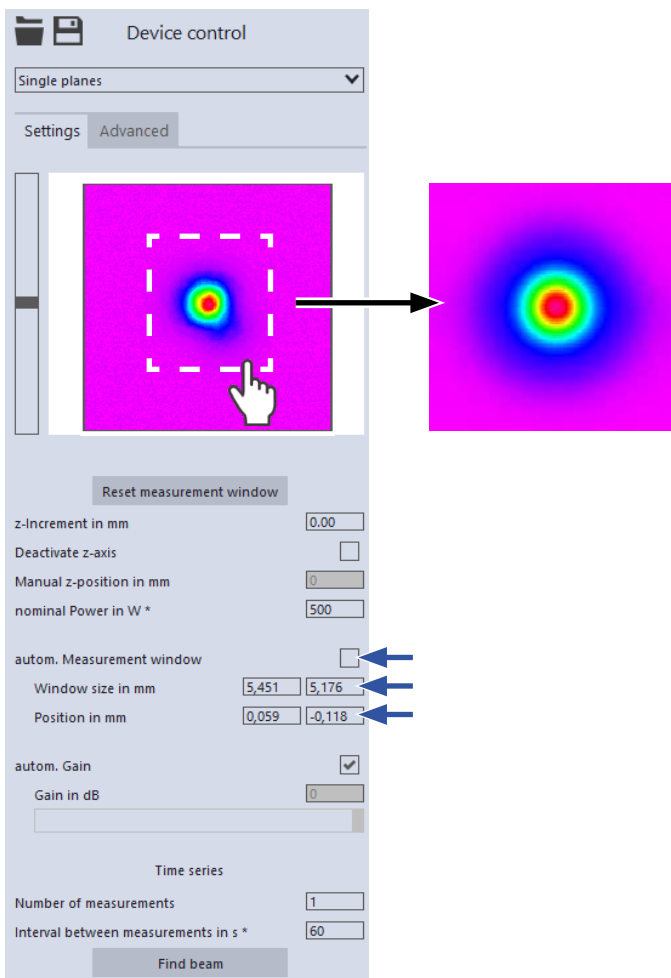

9.8.3 Measure manual caustics with the single plane measurement mode

In **single planes** measurement mode, further measurements can be performed at any z-positions. With this procedure, a caustic can be measured manually.

The FMW+ does not have its own z-axis. The z-axis of the laser system must therefore be used for caustic measurements.

For stigmatic and single astigmatic beams, at least 10 different positions on the z-axis must be measured according to ISO 11146-1. About half of the measurements must be distributed within one Rayleigh length on both sides of the beam waist and about half must be distributed beyond two Rayleigh lengths starting from the beam waist.

An odd number of measurement planes makes it more likely that one of the measurement planes will be at or close to the focal plane. PRIMES recommends measuring at least 21 planes within ± 3 Rayleigh lengths around the focus.

For generally astigmatic and unknown beams, ISO 11146-2 requires measurements to be made at a minimum of 20 uniformly distributed points on the z-axis within a range of at least three times the Rayleigh length both behind and in front of the beam waist.

PRIMES recommends measuring at least 21 planes within ± 3 Rayleigh lengths around the focus. An odd number of measurement planes makes it more likely that one of the measurement planes will be at or close to the focal plane will be measured.

Single measurement with manual input of the z-position:

This procedure is used when the laser system moves to the position of the next measurement.

1. Click on the **Settings** tab.
2. In the **z-position in mm** field, enter the desired position of the next plane to be measured.
3. Start and stop the measurement according to chapter 9.8.4 „Start measurement“ on page 43.

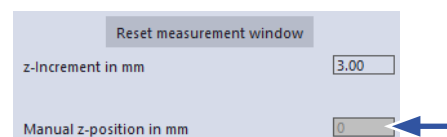

Single measurements using z-increment spacing:

1. Click on the **Settings** tab.
2. Enter the spacing for the further measurements in the **z-Increment in mm** field.
3. Start the measurement according to chapter 9.8.4 „Start measurement“ on page 43 and wait until the measurement is completed.
 - ➔ The measured plane is one z-increment away from the previously measured plane.
4. Move the laser or device according to the entered value.
5. Start a measurement again and wait until the measurement is finished.
6. Repeat the last 2 step as often as you like.

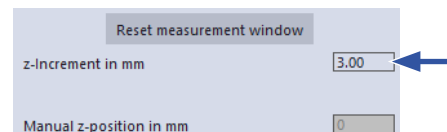

Series measurement using z-increment spacing:

The combination of the *Time series* and *z-Increment in mm* options enables measuring a free caustic in one run.

1. Click on the **Settings** tab.
2. Enter the spacing for the planes to be measured in the *z-Increment in mm* field.
3. In the *Number of measurements* and *Interval between measurements in s* input fields, enter the number of measurements and the interval. The interval is the time between the end of one measurement and the start of the next.
4. Make sure that the laser or device moves within the value entered in the *Interval between measurements in s* input field according to the value entered in the *z-step size* input field.
5. Start the series measurement according to chapter 9.8.4 „Start measurement“ on page 43 and wait until the measurement is finished.

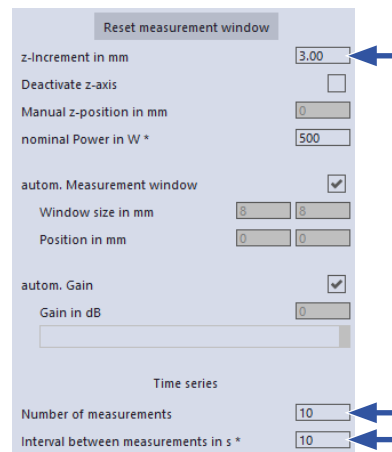

9.8.4 Start measurement

1. Observe the warning messages in chapter 9.1 „Warning messages“ on page 22.
 2. Click the **Start** button.
 3. Switch on the laser.
- ➔ The measurement begins.

Optional:

- ▶ Click the **Stop** button to abort the measurement.
 - ▶ Click the **Stop Rotation** button to stop the rotation of the measuring tip.
- 👁️ During the measurement, the progress is shown in the following indicators:

Measurement:

While the indicator is rotating, the measurement is performed.

Measurement completed:

After successful measurement, the indicator lights up green.

Averaging (if enabled):

The indication shows the measured planes that are used to average a measured value.

4. Switch off the laser after the measurement is completed, unless you want to perform further measurements.

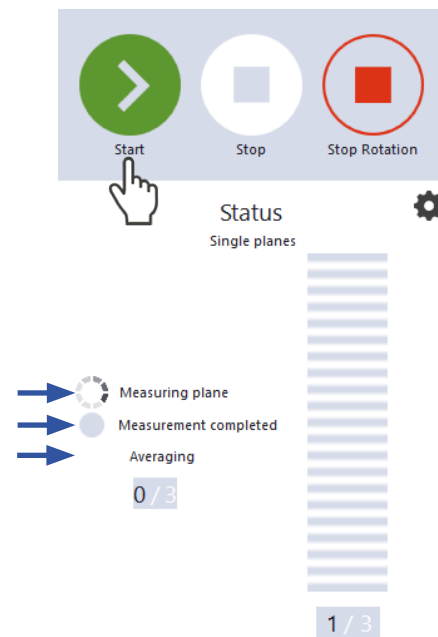

9.8.5 Display measurement results

The measurement results are displayed in the opened tool during and after the completed measurement.

- ▶ PRIMES recommends checking the quality of the results after a measurement. Depending on the results, it may be necessary to repeat the measurement with improved measurement setup or changed parameters.
- ▶ For a detailed description of the file management and evaluation of the measured data, please refer to the separate operating manual LDS.

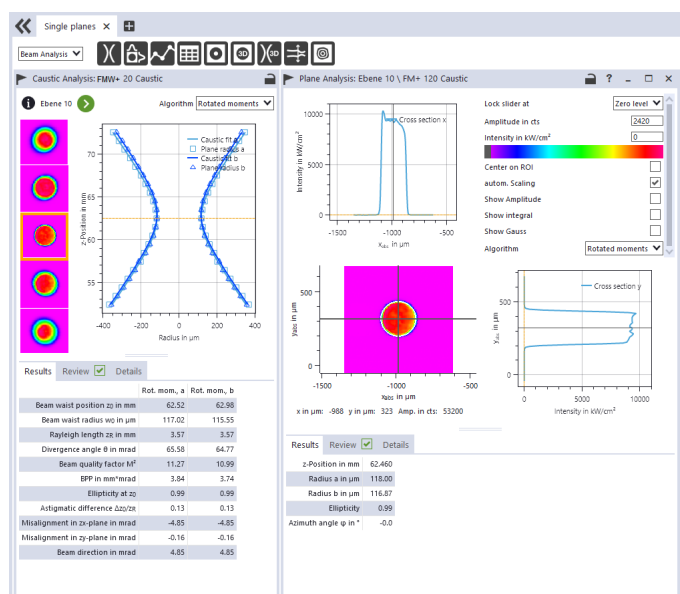

9.9 Monitor

In **Monitor** measuring mode, measuring planes are continuously viewed in a false-color image. The laser beam can be automatically searched by the software in the entire measurement range.

After a successful search the measurement will be run as long as desired. During the measurement, data is continuously read out and displayed in the graphical view. Measurement data are not saved in the project tree of the **Projects** tab.

9.9.1 Search laser beam automatically

1. Observe the warning messages in chapter 9.1 „Warning messages“ on page 22.
 2. Click on the **Settings** tab.
 3. Switch on the laser.
 4. Click on the **Find beam** button.
- ➔ The laser beam is automatically searched for in the entire measuring range. The measurement window and gain are set automatically.

👁 If the search is successful, the laser beam is displayed in the graphic representation.

If the beam is not displayed:

- ▶ Verify the correct alignment of the device on the x-y plane according to chapter 7.2.3 „Align the device“ on page 18.
 - ▶ Check the direction of the beam entrance.
 - ▶ Adjust the gain.
 - ▶ Choose a different z-position.
 - ▶ Increase the laser power (in small increments).
5. If necessary, adjust the measurement window manually according to the following. chapter 9.9.2 „Adjust the measurement window manually“ on page 45 an.
 6. Start the measurement according to chapter 9.9.3 „Start measurement“ on page 46.

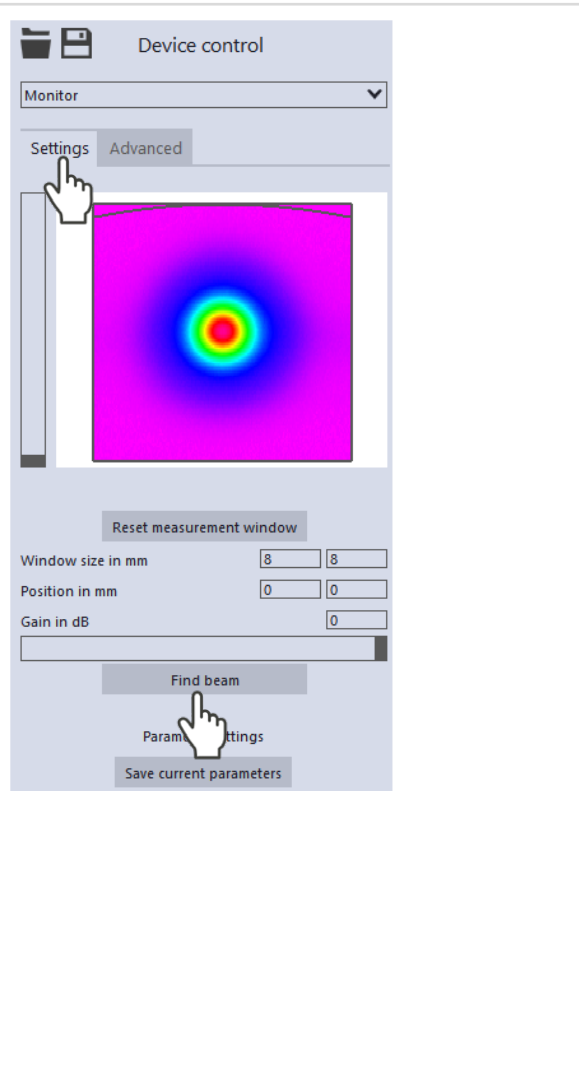

9.9.2 Adjust the measurement window manually

In a window in the upper area of the Settings tab, the measurement plane is displayed graphically:

- the entire measurable area (thin lines)
- the measurement window to be recorded (thick lines)
- the measuring position on the z-axis
- after performing a beam find and during the measurements, a false color view of the recorded area

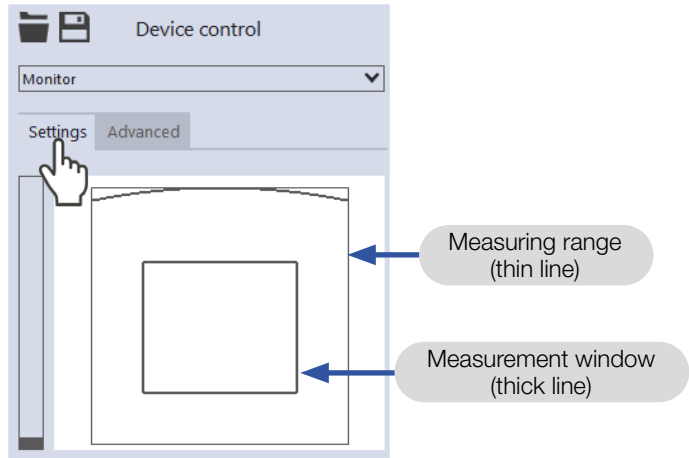

Create a measurement window:

- ▶ Position the mouse pointer anywhere within the measurement range. Drag while holding down the left mouse button. Keep the mouse button pressed until the measurement window meets your requirements.

Adjust the position:

- ▶ Enter the x-/y-position in the corresponding input fields.
- ▶ Position the mouse pointer over the measurement track. Drag while holding down the right mouse button.

With a laser beam displayed:

- ▶ To zoom to the center of the graphic representation, first move the mouse pointer over the graphic representation until the plus/minus buttons appear. Then press the buttons.
- ▶ To zoom in on the position of the mouse pointer, position the mouse pointer anywhere within the graphic representation. Then turn the mouse wheel.
- ▶ To zoom to the size of the measuring range. Position the mouse pointer within the measuring range. Then double-click left.

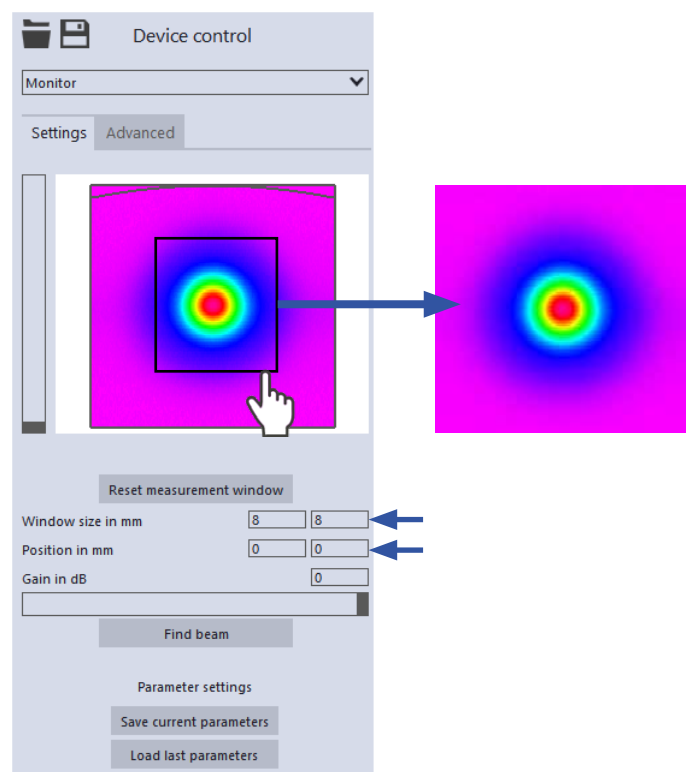

9.9.3 Start measurement

DANGER

Serious injury to the eyes or skin due to laser radiation

If you use a continuous plane measurement to align the device in **Monitor** measurement mode, note the following:

- ▶ Align the device preferably with a pilot laser that cannot cause dangerous reflections.
- ▶ Aligning the device with a class 4 laser can result in dangerous reflections. In this case, the alignment must be remotely controlled behind a separating protective device. The protective device must block the radiation or reduce it to a non-hazardous level.

1. Follow the warning messages in chapter 9.1 „Warning messages“ on page 22.
2. Click the **Start** button.
3. Switch on the laser.
 - ➔ The measurement begins.

Optional:

- ▶ Click the **Stop** button to abort the measurement.
 - ▶ Click the **Stop Rotation** button to stop the rotation of the measuring tip.
- 👁 During the measurement, the progress is shown in the following indicators:

Measurement:

While the indicator is rotating, the measurement is performed.

4. Switch off the laser after the measurement is completed, unless you want to perform further measurements.

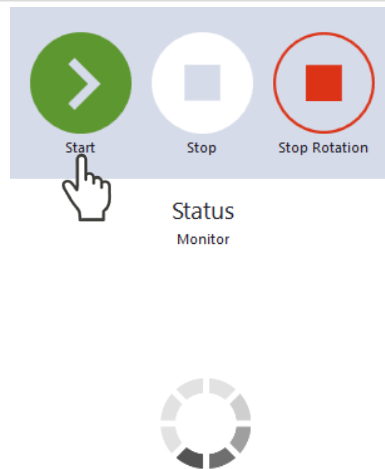

9.9.4 Display measurement results

During the measurement, measurement data is continuously read out and displayed in the graphical view.

The determined measurement data are not saved in the project tree of the Projects tab.

- ▶ For a detailed description of the file management and evaluation of the measured data, please refer to the separate operating manual LDS.

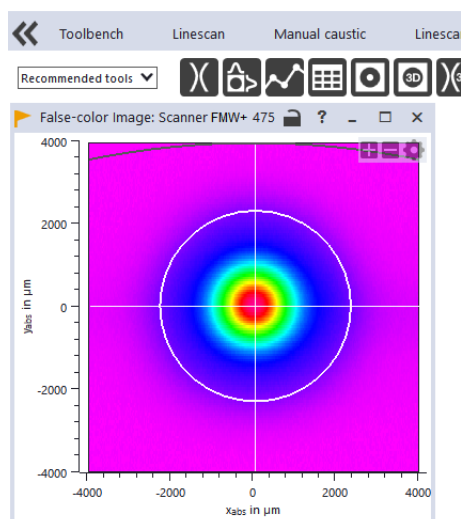

9.10 Determining the tool center point (TCP)

The tool center point (TCP) is usually located on the beam axis on the focus plane.

1. Set up the FMW+ as described in chapter 7.2.3 „Align the device“ on page 18.
2. Install the FMW+ as described in chapter 7.2.4 „Mount the device“ on page 19.
3. Determine the focus position with the FMW+.
4. Measure the distance between the reference plane and the reference plane of the laser processing head.

The distance in the z-direction from the pinhole to the reference plane on the top edge of the device is indicated on the device as an offset of 10.6 mm.

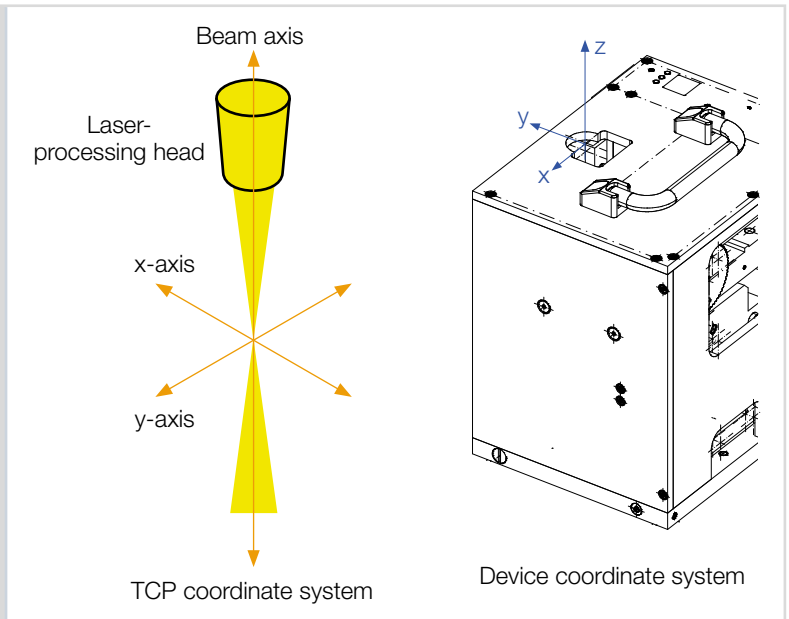

9.10.1 Distance from the pinhole to the reference plane

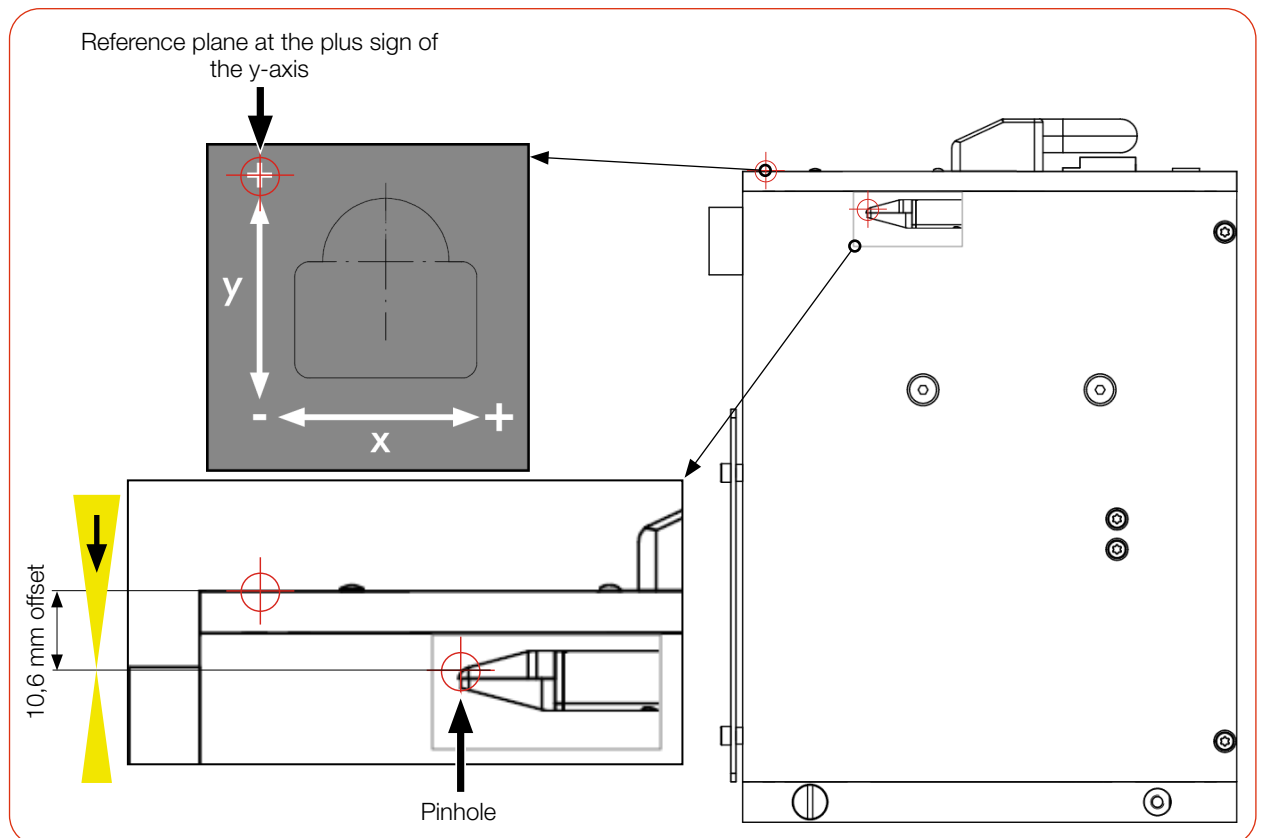
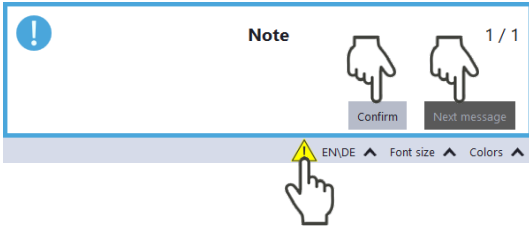
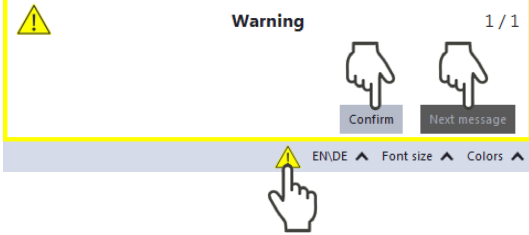

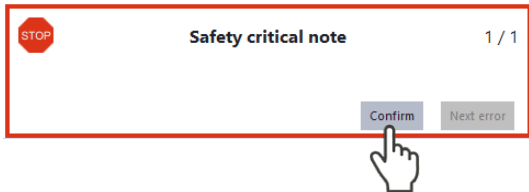

Fig. 9.1: Distance from the pinhole to the reference plane

10 Troubleshooting

10.1 Messages in the LaserDiagnosticsSoftware LDS during measurement

If problems occur during a measurement, the LDS displays them in different categories and different colors.

<p>Note</p> <p>Notes provide assistance in interpreting the measurement results and are displayed in a blue window.</p> <p>Use one of the following options:</p> <ul style="list-style-type: none"> ▶ Click on the warning triangle in the footer to display/hide the window. ▶ If applicable, click the Next message button to display more messages of the same category. ▶ Click the Confirm button to remove the displayed message. 	
<p>Warning</p> <p>Non-safety-critical problems that influence the quality of the measurement results, for example, are displayed in a yellow window.</p> <p>Use one of the following options:</p> <ul style="list-style-type: none"> ▶ Click on the warning triangle in the footer to display/hide the window. ▶ If applicable, click the Next message button to display more messages of the same category. ▶ Click the Confirm button to remove the displayed message. 	
<p>Device error</p> <p>Device errors that can result in damage of the device are displayed in an orange window.</p> <p>In this case, proceed as follows:</p> <ol style="list-style-type: none"> 1. Fix the problem. 2. Click the Confirm button to remove the message. <p>👁 The message disappears. If the problem is not fixed, then the message appears again shortly afterwards.</p> <ol style="list-style-type: none"> 3. Do not proceed with the measurement until the problem is solved. 	
<p>Safety critical note</p> <p>Safety-critical problems that can result in damage/destruction of the device are displayed in a red window.</p> <p>In this case, proceed as follows:</p> <ol style="list-style-type: none"> 1. Fix the problem immediately. 2. Click the Confirm button to remove the message. <p>👁 The message disappears. If the problem is not fixed, then the message appears again shortly afterwards.</p> <ol style="list-style-type: none"> 3. Do not proceed with the measurement until the problem is solved. 	

10.2 Connection error when using the LDS

The firewall may block the connection between the device and the LDS:

- ▶ In **Windows > Control panel > Firewall**, enable the UDP port 20034.

The UDP port should be enabled by a system administrator.

The IP address of the PC is not within the range of the device.

- ▶ In **Windows > Control panel > Network and Sharing Center**, assign an IP address to the PC that is in the same address range as the PRIMES device (e.g. 192.168.116.xyz). The IP address of the PRIMES device can be found on the identification plate.

The IP address should be set by a system administrator.

If several network cards or a USB3-to-Ethernet card are installed in the PC, the connection between device and LDS may be blocked by the selection of the wrong network card.

1. Select the appropriate network card in the **Connections > All** window.

👁️ The device is displayed in the **Connections** window

2. Click on the device.
3. Click on the **Connect to device** button.

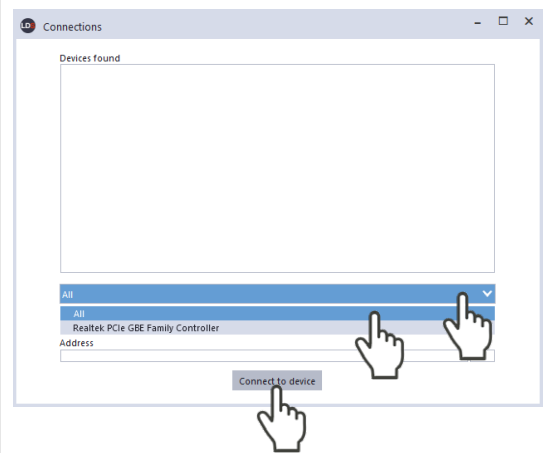

10.3 Other errors

Error	Possible cause	Remedy
Error during a measurement	<ul style="list-style-type: none"> Data transmission error Processor crash in the measuring system Program execution error 	<ol style="list-style-type: none"> Restart the software. Turn off the supply voltage, turn it on again, and start another reset cycle. Restart the computer
Apart from the ambient noise and zero offset, no measuring signal is available.	The device is not aligned correctly.	Check the device alignment to the laser beam.
	The power density in the focus is too low.	Increase the laser power. The absolute power density in the focus typically has to be several hundred kW/cm ² to achieve a significant measuring signal with a standard measuring tip.
	The selected resolution is too low for smaller focus spots (e.g. $r_f = 80 \mu\text{m}$) and a maximum measuring window.	First measure outside the direct focus area. If this does not lead to a result, increase the resolution (e.g. 256 x 256).
	The measuring tip is defective.	Insert a new measuring tip, see chapter 11.3 „Check/replace the measuring tip“ on page 51.
	The measuring tip is installed incorrectly.	Turn the measuring tip around.
	The signal enhancement is too low.	Set the maximum enhancement and select the maximum measuring range.
The measuring tip is destroyed during the measurement.	The power density is too high, igniting plasma on the surface of the measuring tip.	Increase the speed of the measuring tip, see appendix B on page 65 and purge the measuring area with inert gas.
When measuring small beams, an offset of the recorded measuring tracks to one another is observed.	Fluctuations in the synchronisation of the rotation disc and delays in triggering the trigger signal.	Position the beam as close to the left edge of the window as possible. The time interval between the trigger signal and start of the measurement is then smaller and errors can thus be reduced. Averaging is also often helpful in this case.
A lag of the signal in the x-direction can become visible in some cases with the DFY-PS+ detector and very small beams in combination with a high measuring tip velocity.	The response time of the used photodiode of the DFY-PS+ detector.	For such measurements, PRIMES recommends the use of the DFIG-PS+ detector.
Slight differences in sensitivity may occur when using the DFY-PS+ detector in the wavelength range 1,064 - 1,080 nm.	The upper limit of sensitivity of the DFY-PS+ detector is close to the wavelength of solid-state lasers.	For such measurements, PRIMES recommends the use of the DFIG-PS+ detector, which provides a broader wavelength range.

Tab. 10.1: Other errors

11 Maintenance and service

11.1 Maintenance intervals

The operator is responsible for determining the maintenance intervals of the measuring device.

PRIMES recommends a maintenance interval of 12 months for inspection and validation.

If the device is used sporadically (less than once a day), the maintenance interval can be extended up to 24 months.

Please note that the safety and warning functions of the device must be checked regularly.

11.2 Cleaning

Cleaning the device surface

1. After a measurement let the device cool down for an adequate period of time.
2. First clean the device surface with clean and oil-free compressed air.
3. For further cleaning, use a mixture of distilled water and isopropanol in a ratio of approx. 5:1. Use lint-free cleaning cloths that do not cause scratches.
4. If these steps are not sufficient, please contact PRIMES or your PRIMES distributor.

11.3 Check/replace the measuring tip

NOTICE

Damage/Destruction of the measuring tip

The very small pinhole of the measuring tip can quickly become blocked by dirt particles or when touched with bare hands.

- ▶ Wear suitable gloves when installing/removing the measuring tip from the FM+ and make sure that the environment is free of dirt and dust
- ▶ Do not disassemble the measuring tip, otherwise it will become non-functional.

NOTICE

Damage/Destruction of the device

Imbalance of the rotation disc can damage the device.

- ▶ Never operate the device without the measuring tip.

Check measuring tip

The pinhole of a measuring tip can be checked using a HeNe laser.

Remove the measuring tip and shine a 0.5 to 1.0 mW laser into the measuring tip from behind.

The opening in the measuring tip (pinhole) should provide a clear red reflection on the outside.

Remove the measuring tip

1. Unplug the power cord to prevent the device from being accidentally switched on again.

- 2. Turn the rotational disc until the measuring tip becomes visible in the housing recess.
- 3. Turn the drive wheel counterclockwise until the rotation disc protrudes approximately 15 mm into the housing opening.

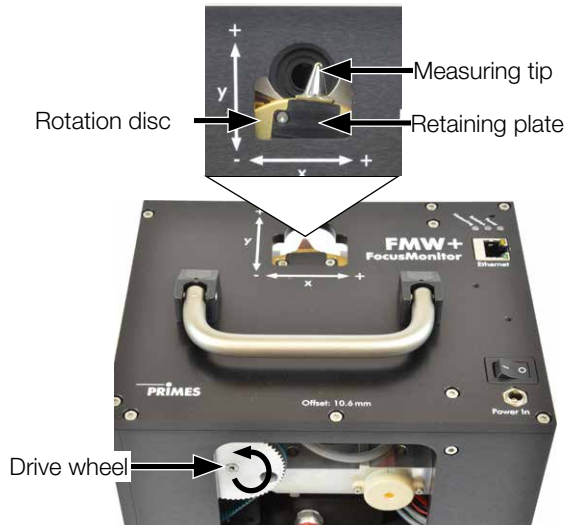

4. Remove the fastening screws of the retaining plate (Torx T8).

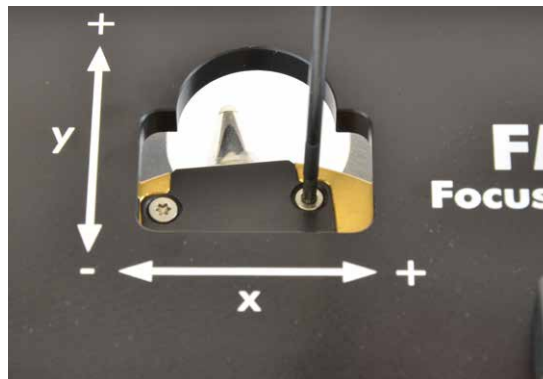

- 5. Carefully push the measuring tip and retaining plate upwards through the housing bore using a screwdriver
- 6. Pull the retaining plate up slightly and then forwards until it loosens and can be removed easily.

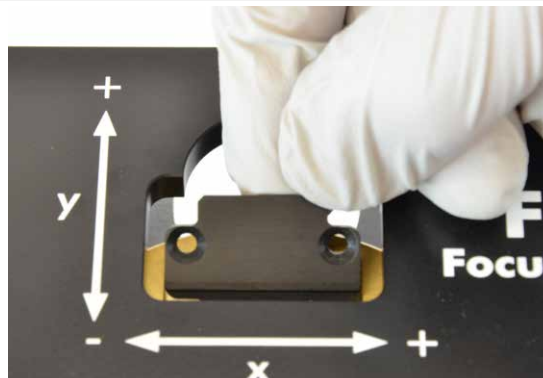

7. Carefully remove the measuring tip.

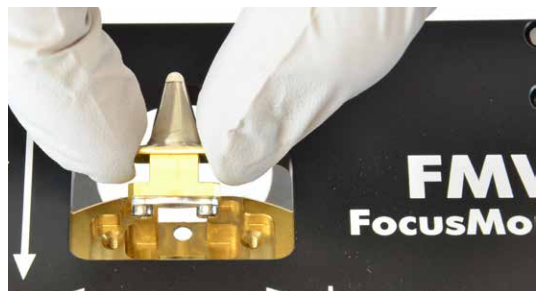

Install the measuring tip

 **DANGER**
Serious eye or skin injury due to laser radiation/Destruction of the measuring tip

If the laser beam hits the measuring tip in the beam path, it could be destroyed and scattered or directed reflection of the laser beam (laser class 4) occurs.

- ▶ After installation, move the measuring tip out of the beam path.

1. Insert the new measuring tip
The inlet aperture is located on the convex side (see Fig. 7.1 on page 17).

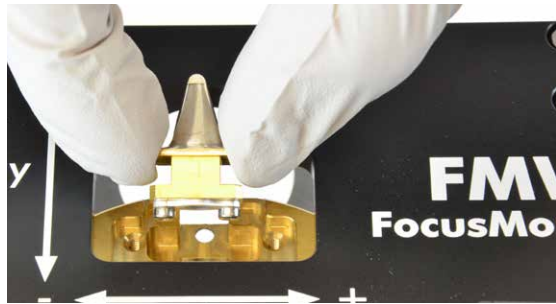

2. Use up and down movements to insert the retaining plate into the rotational disc at an angle of about 45 degrees, ensuring that the guide groove is pointing upwards. Then push it down into the recess
 - ▶ Check whether the retaining plate is positioned correctly by lightly pressing the front edge.

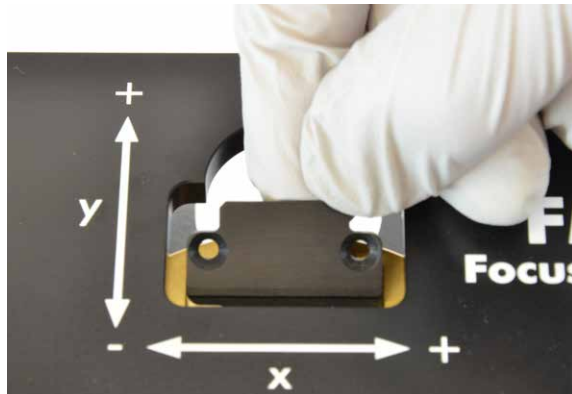

3. Insert the fastening screws (Torx T8) and tighten hand-tight.
4. Move the measuring tip out of the beam path.

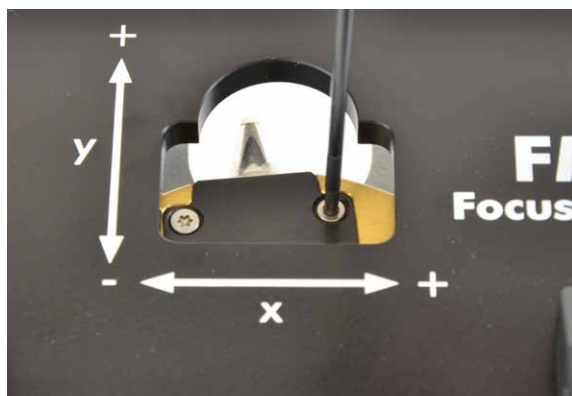

11.4 Replace detector

Generally, the FMW+ is equipped with a DFIG-PS+ detector.

Detectors with different sensitivity or different time behavior can be used for special applications.

More information regarding the variety of detectors to ensure an optimum configuration of the FMW+ is provided in chapter 11.5 „Selection of the measuring tip and the detector“ on page 59.



Caution

Risk of burns

The absorber is hot after a measurement!
Accidentally touching the absorber can cause burns.

- ▶ Do not change the detector directly after a measurement.
- ▶ Allow the device to cool down for an appropriate period of time. The cooling time varies depending on the laser power and irradiation time.

NOTICE

Damage of the detector

Touching the sensor surface will damage the detector. This can negatively affect the measuring results.

- ▶ Do not touch the detector with your fingers on the sensor surface.
- ▶ Do not place the detector on the sensor surface to avoid scratches.

Replace detector

1. Unplug the power cord to prevent the device from being accidentally switched on again.

2. Turn the drive wheel counterclockwise until it stops.
The detector is now in a position where it can be dismantled.



3. Carefully detach the black plug (A) and then the gold-colored angled plug (B) from the detector (e.g. using needle-nose pliers).

▶ Don't pull the cables!

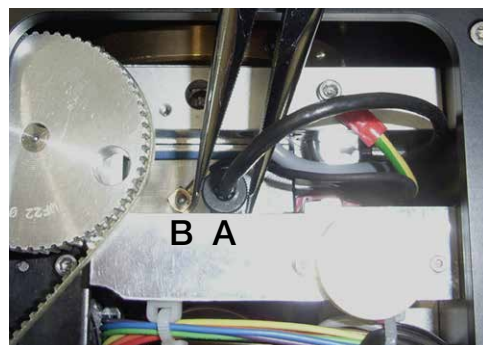

4. Remove the retaining screws on both sides of the base plate.

▶ Note that the screws are of different lengths.



5. Tilt the housing backwards.



FMW+ when unfolded.

- ▶ The absorber is hot after a measurement!
Accidentally touching the absorber can cause burns.

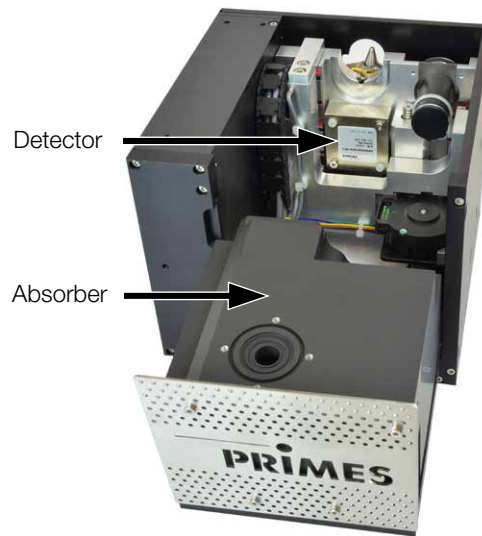

6. Remove the plastic screws (D) of the detector using the short screwdriver (included).

- ▶ Never remove the two Torx screws.

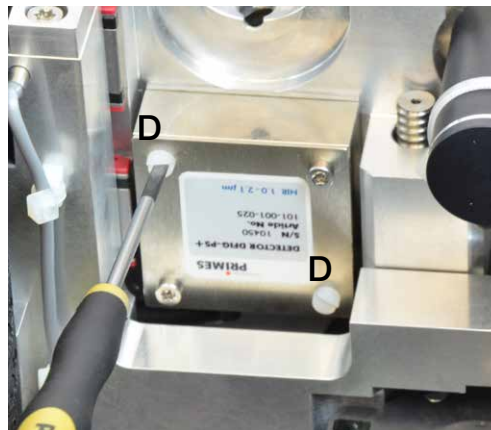

7. Remove the detector.

- ▶ Do not touch the detector with your fingers on the sensor surface.
- ▶ Do not place the detector on the sensor surface to avoid scratches.

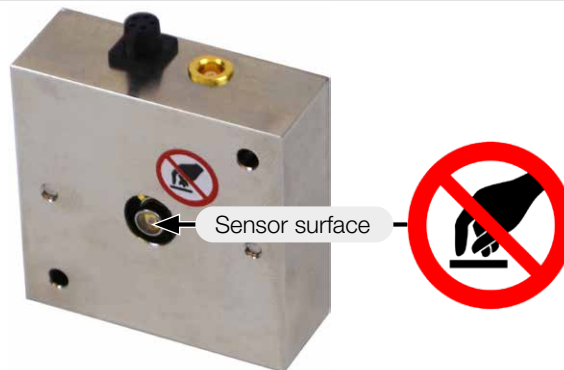

Assemble detector

NOTICE

Blocking the rotational disc

Do not forget the foam rubber spacer during installation, otherwise the rotational disc could be mechanically blocked by the screws.

The foam rubber spacer also ensures mechanical isolation of the detector.

- ▶ Only tighten the plastic screws **hand-tight**. The foam rubber spacer must only be compressed to no less than half its original thickness.



Only use isolating plastic screws to fasten the detector to prevent any electric noise signals from being interspersed.

Install the new detector in reverse order.

1. To install the new detector, first place the foam rubber spacer (C) (included in the scope of delivery) on the mounting surface of the detector.

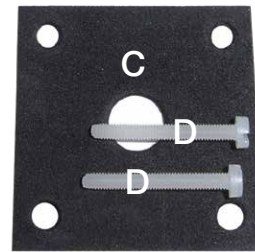

2. Center the detector to the housing.
 3. Fasten the detector with the two plastic screws (D).
- ▶ Only tighten the plastic screws **hand-tight**. The foam rubber spacer must not be compressed to more than half its original thickness.

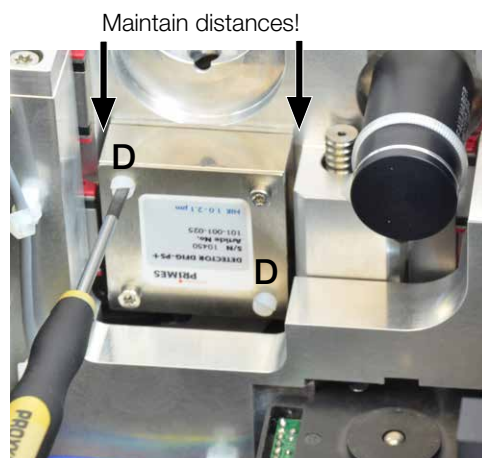

4. Tilt the housing forward.



5. Screw in the retaining screws on both sides of the base plate.

► Note that the screws are of different lengths.



6. Then first connect the gold-colored right-angle connector (B) and then the black connector (A).

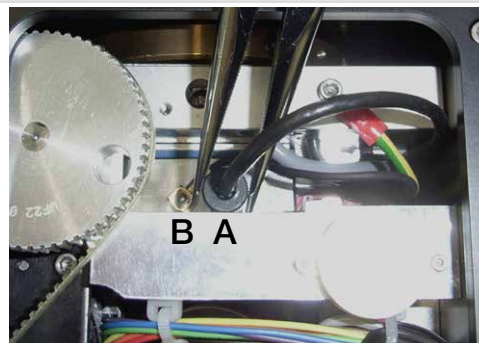

11.5 Selection of the measuring tip and the detector

Depending on the laser type, you must use the appropriate measuring tip and detector. The measuring tips and detectors are available for different wavelengths, power density ranges, or beam divergences so that measurements can be recorded at a maximum power in each case.

This ensures that an optimum configuration of the FMW+ is achieved. Only one value can be exploited fully for the power or power density.

The service life of the measuring tips depends not only on the power density but also on the cleanliness of the surface (dust, particles, fingerprints). Therefore, the measuring tips must be treated very carefully.

Measuring tips specifications and selection of suitable detectors

The measuring tips are suitable for different power densities depending on the design. The power density depends on the laser power and focus size.

Observe the destruction limits of the measuring tips in appendix B on page 65.

Measuring tips	CO ₂ high power	NIR high div	Diode
Typical pinhole diameter in μm	20 – 25	20	50
Beam divergence/acceptance angle in mrad	< 240	< 200	< 500
Typical wavelength in nm	9 000 – 12 000	400 – 1 700	400 – 1 700
CO₂-laser	Max. power density in MW/cm		
Laser power up to 1 kW	20	—	—
NIR-laser	Max. power density in MW/cm		
Laser power up to 1 kW	—	5	2.5
VIS-laser	Max. power density in MW/cm		
Laser power up to 1 kW	—	5	—
Suitable detectors			
Detector types	DFC+	DFIG-PS+, DFY-PS+	DFIG-PS+, DFY-PS+

Tab. 11.1: Measuring tips specifications and selection of suitable detectors

Detector specifications

Detector types	DFC+	DFY-PS+	DFIG-PS+
Laser	CO ₂	NIR/VIS	NIR
Sensor typ	Pyroelectric	Photodiode	Photodiode
Amplification	1	Automatic adjustment	Automatic adjustment
Wavelength range in nm	9 000 – 12 000	400 – 1 100	800 – 2 100
Min. beam diameter at 1 875/3 750 min ⁻¹	—	100 (800 – 1 100 nm)	100

Tab. 11.2: Detectors specifications

12 Measures for the product disposal

As a B2B device, this PRIMES measuring device is subject to the European Waste Electrical and Electronic Equipment (WEEE) Directive and the corresponding national laws. The WEEE directive obliges the operating company to dispose of the device in an environmentally sound manner, not with household waste, but in a separate WEEE collection.

PRIMES gives the opportunity to return PRIMES measuring devices for free disposal within the scope of the Waste of Electrical and Electronic Equipment (WEEE Directive). This service does not include shipping costs. Send PRIMES measuring devices to be disposed of within the EU to our address:

PRIMES GmbH
Max-Planck-Str. 2
64319 Pfungstadt
Germany

If you are located outside the EU, please contact your local PRIMES distributor to discuss the disposal procedure for your PRIMES measuring device.

PRIMES is registered at the german „joint body“ for producers „Stiftung Elektro-Altgeräte Register“ (Stiftung EAR). Our number is: WEEE-reg.-no. DE65549202.

13 Declaration of conformity

Original EG Declaration of Conformity

The manufacturer: PRIMES GmbH, Max-Planck-Straße 2, 64319 Pfungstadt, Germany,
hereby declares that the device with the designation:

FocusMonitor (FM)

Types: FM 35; FM 120; FM+; FM+ HPD; FMW; FMW+

is in conformity with the following relevant EC Directives:

- Machinery Directive 2006/42/EC
- EMC Directive EMC 2014/30/EU
- Directive 2014/32/EC on measuring instruments
- Low voltage Directive 2014/35/EU
- Directive 2011/65/EC on the restriction of the use of certain hazardous substances (RoHS) in electrical and electronic equipment

Authorized for the documentation:
PRIMES GmbH, Max-Planck-Straße 2, 64319 Pfungstadt, Germany

The manufacturer obligates himself to provide the national authority in charge with technical documents in response to a duly substantiated request within an adequate period of time.

Pfungstadt, February 16, 2022



Dr. Reinhard Kramer, CEO

14 Technical data

Measurement parameters		
Power range ¹⁾		up to 1 000 W
Wavelength range		400 – 12 000 nm
Beam dimensions		100 – 3 000 µm
Max. power density range CO ₂ - and NIR laser		90 kJ
Max. power density (depending on measuring tip)	CO ₂ laser (10 600 nm)	20 MW/cm ²
	Nd:YAG laser (1 000 – 1 100 nm)	5 MW/cm ²
	VIS laser (515 – 550 nm)	5 MW/cm ²
	Dioden laser (800 – 1 000 nm)	2.5 MW/cm ²
Max. beam divergence (depending on measuring tip)	NIR high div	240 mrad
	CO ₂ high power	200 mrad
	Diode	500 mrad
Determined parameters		
Focus position x, y, z		yes (with external z-axis)
Focus radius x, y		yes
Beam quality factor M ²		yes
Raw beam diameter at the focusing element		yes
Beam parameter product		yes
Divergence angle		yes
Power density distribution		2D, 3D
Device parameters		
Working range x-y		8 x 8 mm
Resolution		32 x 32 to 1 024 x 1 024 pixel
Speed of measuring tip		1875, 3750 min ⁻¹
Supply data		
Power supply		24 V DC ± 5 %, max. 1.8 A
Communication		
Interface		Ethernet
Dimensions and weight		
Dimensions (L x B x H)		185.5 x 153 x 208.5 mm
Weight (approx.)		8 kg
Environmental conditions		
Operating temperature range		10 – 40 °C
Storage temperature range		5 – 50 °C
Reference temperature		22 °C
Permissible relative humidity (non-condensing)		10 – 80 %

¹⁾ No general performance limit. It is not permissible to exhaust the extremes of individual technical data at the same time.

15 Dimensions

If not otherwise stated, all dimensions are in millimeters (mm).

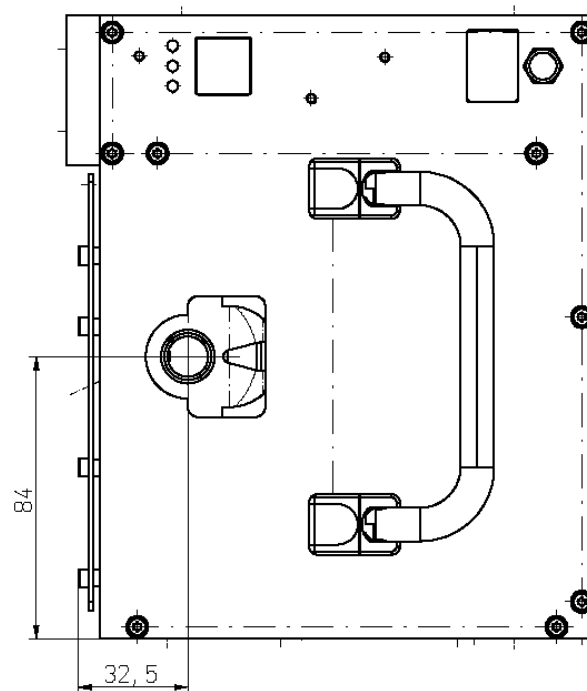
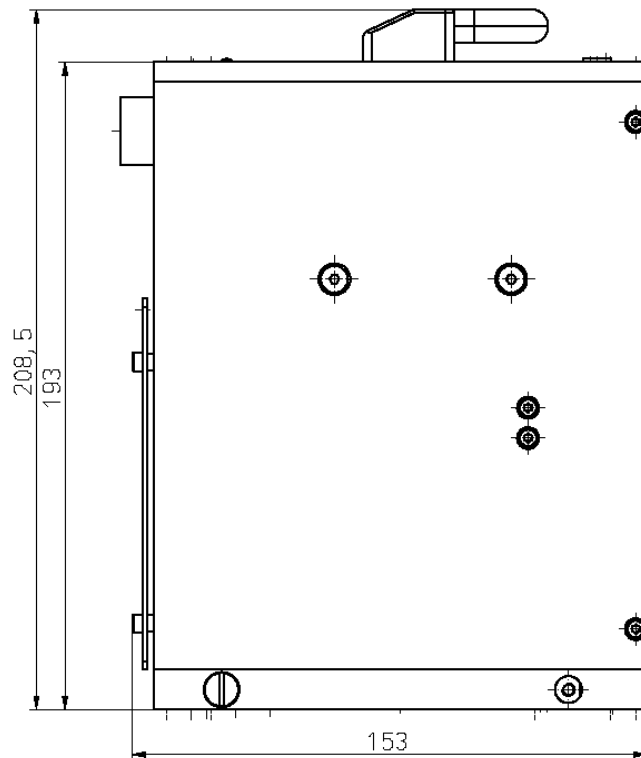

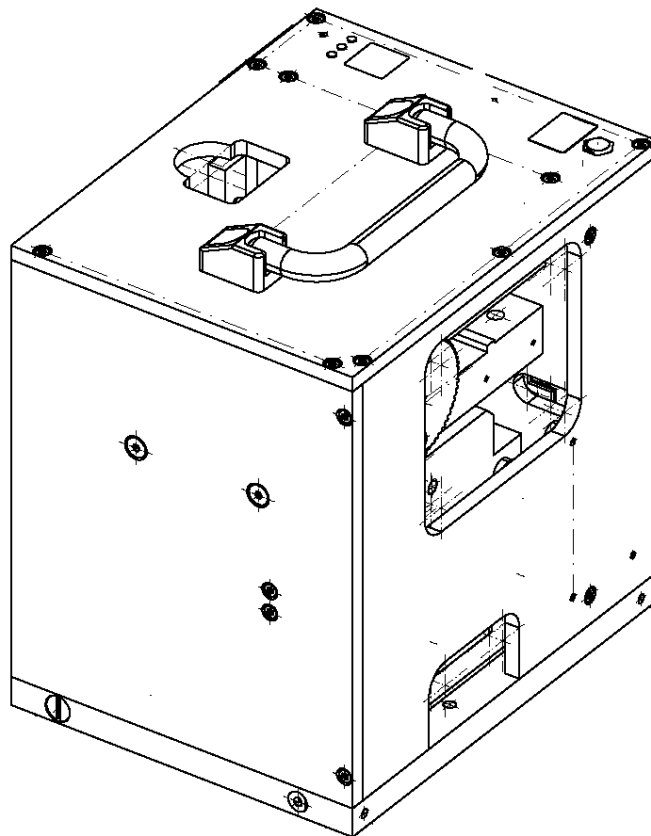
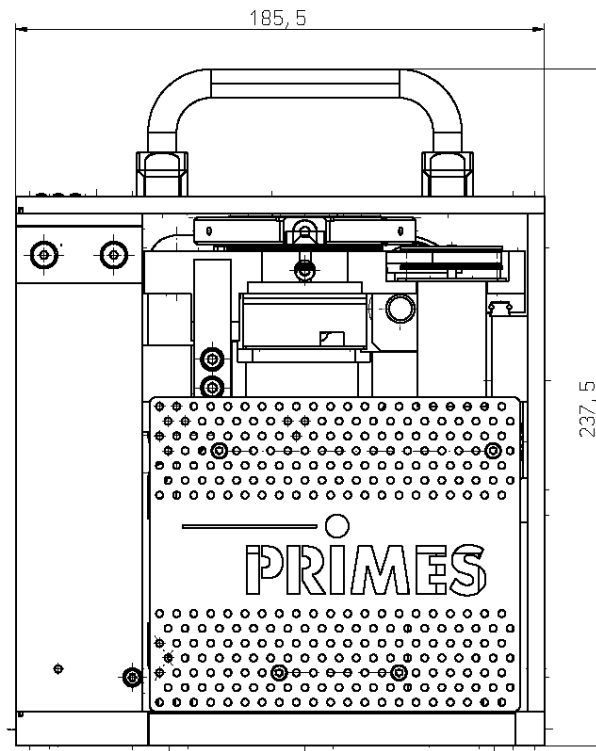

16 Appendix

A GNU GPL license notice

The software of this product contains software code that is licensed subject to the GNU General Public License (GPL) Version 2 or later. The license terms of the GNU GPL Version 2 or later are available on the following websites:

- <https://www.gnu.org/licenses/old-licenses/gpl-2.0>
- <https://www.gnu.org/licenses/>

B Determine the speed of the measuring tip used

The calculations assume a Gaussian profile.

The maximum power density in real beams with the same dimensions is often slightly smaller (typically minus 10 – 20%, minus 50% for a tophat distribution).

In case of doubt, start with a lower laser power.

B.1 Limits for measuring operation

Table element	White	Green	Red
Speed in min ⁻¹	1875	3750	Risk of destruction!

Focus diameter in μm	CO2 high power measuring tip			NIR high div measuring tip			Diode measuring tip		
	0,1	0,5	1	0,1	0,5	1	0,1	0,5	1
70	5,20	25,98	51,97	5,20	25,98	51,97	5,20	25,98	51,97
80	3,98	19,89	39,79	3,98	19,89	39,79	3,98	19,89	39,79
90	3,14	15,72	31,44	3,14	15,72	31,44	3,14	15,72	31,44
100	2,55	12,73	25,46	2,55	12,73	25,46	2,55	12,73	25,46
125	1,63	8,15	16,30	1,63	8,15	16,30	1,63	8,15	16,30
150	1,13	5,66	11,32	1,13	5,66	11,32	1,13	5,66	11,32
175	0,83	4,16	8,32	0,83	4,16	8,32	0,83	4,16	8,32
200	0,64	3,18	6,37	0,64	3,18	6,37	0,64	3,18	6,37
225	0,50	2,52	5,03	0,50	2,52	5,03	0,50	2,52	5,03
250	0,41	2,04	4,07	0,41	2,04	4,07	0,41	2,04	4,07
275	0,34	1,68	3,37	0,34	1,68	3,37	0,34	1,68	3,37
300	0,28	1,41	2,83	0,28	1,41	2,83	0,28	1,41	2,83
325	0,24	1,21	2,41	0,24	1,21	2,41	0,24	1,21	2,41
350	0,21	1,04	2,08	0,21	1,04	2,08	0,21	1,04	2,08
375	0,18	0,91	1,81	0,18	0,91	1,81	0,18	0,91	1,81
400	0,16	0,80	1,59	0,16	0,80	1,59	0,16	0,80	1,59
425	0,14	0,70	1,41	0,14	0,70	1,41	0,14	0,70	1,41
450	0,13	0,63	1,26	0,13	0,63	1,26	0,13	0,63	1,26
475	0,11	0,56	1,13	0,11	0,56	1,13	0,11	0,56	1,13
500	0,10	0,51	1,02	0,10	0,51	1,02	0,10	0,51	1,02
525	0,09	0,46	0,92	0,09	0,46	0,92	0,09	0,46	0,92
550	0,08	0,42	0,84	0,08	0,42	0,84	0,08	0,42	0,84
575	0,08	0,39	0,77	0,08	0,39	0,77	0,08	0,39	0,77
600	0,07	0,35	0,71	0,07	0,35	0,71	0,07	0,35	0,71
625	0,07	0,33	0,65	0,07	0,33	0,65	0,07	0,33	0,65
650	0,06	0,30	0,60	0,06	0,30	0,60	0,06	0,30	0,60
675	0,06	0,28	0,56	0,06	0,28	0,56	0,06	0,28	0,56
700	0,052	0,26	0,52	0,052	0,26	0,52	0,052	0,26	0,52
725	0,048	0,24	0,48	0,048	0,24	0,48	0,048	0,24	0,48
750	0,045	0,23	0,45	0,045	0,23	0,45	0,045	0,23	0,45
775	0,042	0,21	0,42	0,042	0,21	0,42	0,042	0,21	0,42
800	0,040	0,20	0,40	0,040	0,20	0,40	0,040	0,20	0,40
850	0,035	0,18	0,35	0,035	0,18	0,35	0,035	0,18	0,35
900	0,031	0,16	0,31	0,031	0,16	0,31	0,031	0,16	0,31
950	0,028	0,14	0,28	0,028	0,14	0,28	0,028	0,14	0,28
1000	0,025	0,13	0,25	0,025	0,13	0,25	0,025	0,13	0,25
1500	0,011	0,06	0,11	0,011	0,06	0,11	0,011	0,06	0,11
2000	0,006	0,03	0,06	0,006	0,03	0,06	0,006	0,03	0,06
3000	0,003	0,01	0,03	0,003	0,01	0,03	0,003	0,01	0,03

 Tab. B.1: Power density in MW/cm²

