

Operating Manual

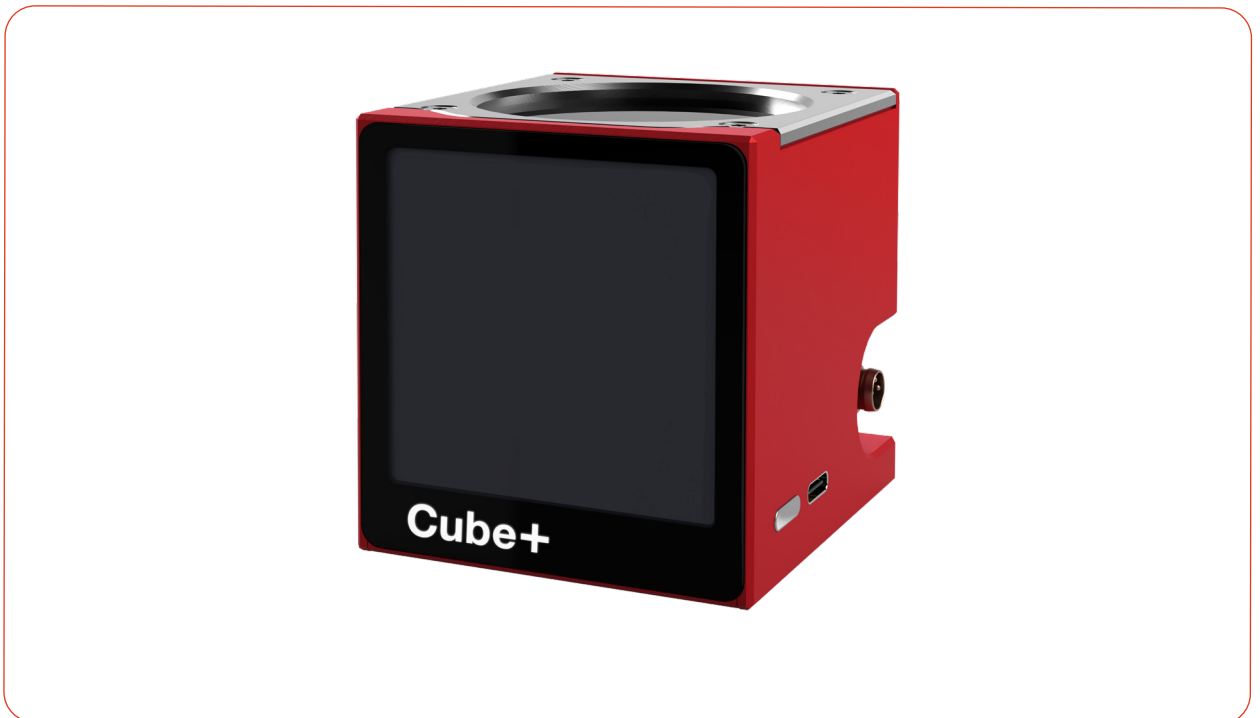

Cube+

LaserDiagnosticsSoftware LDS

SpotLight App

IMPORTANT!

READ CAREFULLY BEFORE USE.

KEEP FOR FUTURE USE.

Table of contents

1	Basic safety notes	7
2	Icons and conventions	8
3	Transport and storage	10
4	About this operating manual	11
5	Device description	11
5.1	Scope of delivery and optional accessories	11
5.2	Important notes on the lithium-ion battery	12
5.3	Functional description	12
5.4	Measuring principle	13
5.5	On/Off button	13
5.6	Display	13
6	Connections	14
6.1	Overview of connections	14
6.2	USB	14
6.3	Bluetooth®	15
6.4	Safety interlock	15
7	Mounting	16
7.1	Conditions at the installation site	16
7.2	Installation in the laser system	16
7.2.1	Prepare mounting	16
7.2.2	Possible mounting positions	16
7.2.3	Align the Cube+	16
7.2.4	Mount the Cube+	17
7.3	Removal from the laser system	17
8	Software installation	18
8.1	Install LDS	18
9	Laser parameter setting	18
9.1	Setting the laser rise time	18
9.2	Maximum permissible power density	19
9.3	Minimum and maximum energy input per measurement	20
9.4	Waiting times until the next measurement in serial measurements	21
9.5	Measurement with pulsed lasers	21
10	Measure	22
10.1	Warning messages	22
10.2	Measuring as stand-alone-device	23
10.2.1	Start measurement	23
10.3	Measuring with the LDS	25
10.3.1	Connect/disconnect the Cube+ with the LDS	25
10.3.2	Settings in the device control	26
10.3.3	Start measurement	27
10.3.4	Measuring results display	27
10.3.5	Delete measurements	29
10.4	Measuring with the optional SpotLight app	30

11	Troubleshooting	31
11.1	LDS messages during measurement.....	31
11.2	Connection failures.....	32
11.3	Other errors.....	32
12	Maintenance and service	33
12.1	Maintenance intervals.....	33
12.2	Cleaning.....	33
12.3	Protective window.....	33
13	Measures for the product disposal	35
14	Declaration of conformity	36
15	Technical data	37
16	Dimensions	38
17	Appendix	39
A	Diagrams for determining the max. laser power.....	39

PRIMES - the company

PRIMES is a manufacturer of measuring devices for the analysis of laser beams.

These devices are used for the diagnostics of high-power lasers. This ranges from CO₂ lasers to solid-state and fiber lasers to diode lasers and the wavelength ranges from UV to IR.

A wide range of measuring devices is available to determine the following beam parameters:

- Laser power
- Beam dimensions and position of an unfocused beam
- Beam dimensions and position of a focused beam
- Beam quality factor M^2

Development, production and calibration of the measuring devices is performed at PRIMES. This guarantees optimum quality, excellent service, and a short reaction time, providing the basis for us to meet all of our customers' requirements quickly and reliably.



PRIMES GmbH
Max-Planck-Str. 2
64319 Pfungstadt
Deutschland

Tel. +49 6157 9878-0
info@primes.de
www.primes.de

1 Basic safety notes

Intended use

The device has been designed exclusively for measurements in the beam of high-power lasers.

Use for any other purpose is considered as not intended and is strictly prohibited. Furthermore, intended use requires that all information, instructions, safety notes and warning messages in this operating manual are observed. The specifications given in chapter 15 „Technical data“ on page 37 apply. Any given limit values must be complied with.

If not used as intended, the device or the system in which the device is installed can be damaged or destroyed. In addition, there is an increased risk to health and life. Only use the device in such a way that there is no risk of injury.

This operating manual is an integral part of the device and must be kept in the immediate vicinity of the place of use, accessible to personnel at all times.

Every person who is responsible for the installation, start-up or operation of the device must have read and understood the operating manual and, in particular, the safety instructions.

If you still have questions after reading this operating manual, please contact PRIMES or your supplier for your own safety.

Observing applicable safety regulations

Observe the safety-relevant laws, guidelines, standards and regulations in the current editions published by the state, standardization organizations, professional associations, etc. In particular, observe the regulations on laser safety and comply with their requirements.

Necessary safety measures

The device measures direct laser radiation, but does not emit any radiation itself. However, during the measurement the laser beam is directed at the device. This produces scattered or directed reflection of the laser beam (laser class 4). The reflected beam is usually not visible.

Protect yourself from direct and reflected laser radiation while working with the device by taking the following measures:

- Never leave the device unattended when taking measurements.
- Wear **safety goggles** adapted to the power, power density, laser wavelength and operating mode of the laser beam source in use.
- Wear suitable **protective clothing** or **protective gloves** if necessary.
- If possible, also protect yourself from direct laser radiation and scattered radiation by using separating protective devices that block or attenuate the radiation.
- If the device is moved from its aligned position, increased scattered or directed reflection of the laser beam occurs during measuring operation. Mount the device in such a way that it cannot be moved unintentionally, i.e. by bumping or pulling the cables.
- Connect the laser control's safety interlock to the device. Check that the safety interlock will switch off the laser properly in case of error.
- Install safety switches or emergency safety mechanisms that allow the laser to be switched off immediately.
- Use suitable beam guidance and beam absorber elements which do not emit any hazardous substances when irradiated.

Employing qualified personnel

The device may only be operated by qualified personnel. The qualified personnel must have been instructed in the installation and operation of the device and must have a basic understanding of working with high-power lasers, beam guiding systems and focusing units.

Conversions and modifications

The device may not be modified in terms of design or safety without the explicit consent of the manufacturer. The same applies to unauthorized opening, dismantling and repair. The removal of covers is only permitted within the scope of the intended use.

Liability disclaimer

Manufacturer and distributor exclude any liability for damages and injuries which are direct or indirect consequences of using the device not as intended or modifying the device or the associated software without authorization.

2 Icons and conventions

Warning messages

The following icons and signal words indicate possible residual risks in the form of warnings:



DANGER

Means that death or serious physical injuries **will** occur if necessary safety precautions are not taken.



WARNING

Means that death or serious physical injuries **may** occur if necessary safety precautions are not taken.



CAUTION

Means that minor physical injury **may** occur if necessary safety precautions are not taken.

NOTICE

Means that property damage **may** occur if necessary safety precautions are not taken.

Product safety labels

The following icons are used on the device itself to indicate imperatives and possible dangers:



Read and understand the operating manual before using the device!



Labeling according to WEEE directive:

The device must not be disposed of with household waste, but in a separate WEEE collection in an environmentally friendly way.



Do not touch!

Further icons and conventions in this operating manual



Here you will find useful information and helpful tips.

- ▶ Indicates a single instruction.
If several of these instructions appear one below the other, the order in which they are executed is irrelevant or they represent alternative courses of action.
- 1. A numbered list identifies a sequence of instructions that must be executed in the specified order.
- 2.
- ...
- ➔ Indicates the result of an action to explain processes that take place in the background.
- 👁 Indicates an observation prompt to draw attention to visible feedback from the device or the software.
Observation prompts make it easier to check whether an instruction was executed successfully. Often they also guide to the next instruction.
- 👉 Points to a control element that is to be pressed / clicked.
- ➔ Points to an element described in the text (for example an input field).

3 Transport and storage

Warning messages

NOTICE

Damage/Destruction of the device

Hard hits or falls may damage the device.

- ▶ Handle the device carefully when transporting it.

NOTICE

Damage/Destruction of the device

At high temperatures, the battery may catch fire.

- ▶ Do not expose the device to high temperatures and refer to the information in chapter 15 „Technical data“ on page 37.

Shipping the device

The device is equipped with a permanently installed lithium-ion battery. A removal of the battery is not intended.

The device is to be considered as hazardous good.

- ▶ Please observe the valid regulations for shipping.

Particularly in case of a damaged battery, special regulations must be observed:

Damaged batteries can cause fire! These batteries must be checked by qualified personnel and, if necessary, sorted out or repacked!

Battery details for shipping:

Cell/battery type: Lithium Ion

Cell or battery: Battery

LC or Wh rating: 6.7 Wh

Cell/battery weight: 29 g

UN-Classification: UN 3481: Lithium ion batteries contained in equipment

Storing the device

Store the device in a cool, dry place. Keep a minimum distance of 3 m from combustible materials.

Do not expose the device to direct sunlight.

Check the battery charge level at least once every three months; it should be between 30% and 70%.

4 About this operating manual

This manual describes the installation and operation of the Cube+ and performing measurements:

- as a stand-alone-device
- using the optional SpotLight App
- using the optional LaserDiagnosticsSoftware LDS version 4.1 or higher

The abbreviation LDS is used in this operating manual.

With the PRIMES SpotLight app for iOS and Android, measurements can be analyzed and documented on the go, right on a smartphone.

For measurement operation with a PC, the optional LDS must be installed on the PC.
For more information see: www.primes.de/de/support/downloads/software.

This manual includes a brief introduction on using the LDS for measurements. For a detailed description refer to the separate operating manual “LDS” or the built-in online help.



This operating manual describes the software version valid at the time of writing.
Check whether a newer version is available using the QR code or at:
www.primes.de/en/support/downloads/software.



5 Device description

5.1 Scope of delivery and optional accessories

The following parts are within the scope of delivery:

- Cube+
- Cable USB 3.0, USB-A/USB-C, 2 m
- Safety interlock cable with one-sided connector M8, 2 m
- Transport and storage bag

The following accessories are available:

- LaserDiagnosticsSoftware LDS
- SpotLight app

5.2 Important notes on the lithium-ion battery

WARNING

Health and environmental risks

If the battery is damaged, liquids (electrolytes) may leak. These are corrosive and may release toxic gases. At high temperatures, the battery may catch fire.

- ▶ Handle the device with care.
- ▶ Do not expose the device to high temperatures.
- ▶ In case of damage: Do not inhale vapors; avoid contact with eyes and skin.

Charging the battery

The battery has a capacity of 1,800 mAh. The battery can be charged with a max. charging current of 1 A. The charging time is approx. 1 hour. At a charging current of 500 mA, the charging time is approx. 2.5 hours. Fully charge the battery before using the Cube+ for the first time. The first full charge takes approx. 3 hours. Use only the included USB cable for charging. Do not leave the battery charging unattended, e.g., overnight.

5.3 Functional description

Thanks to its one-button operation, the Cube+ is ready to use right away—without complex settings. It measures laser powers from 25 W to 12 kW, making it suitable for a wide range of industrial applications. Modern interfaces enable easy integration into existing measurement and production environments. With a USB-C port and an API interface for automated measurements, the Cube+ offers easy integration into digital workflow. Using the PRIMES SpotLight app for iOS and Android, measurements can be evaluated and documented directly on a smartphone. Connecting the Cube+ to the LDS offers even more possibilities for analysis, documentation, and process control.

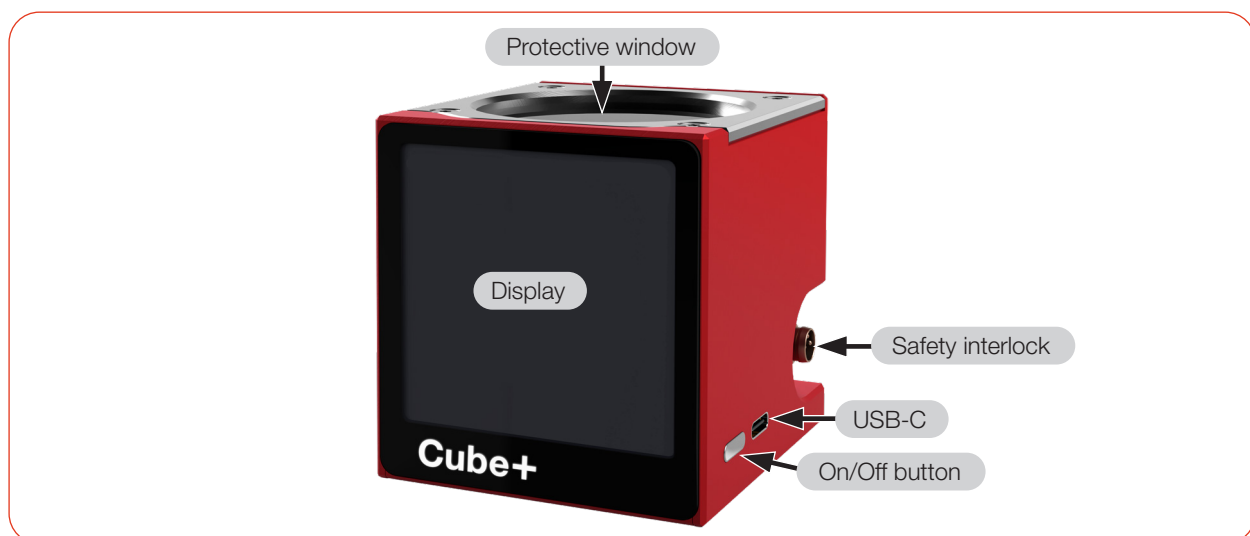

Fig. 5.1: Functional description

5.4 Measuring principle

The Cube+ determines the power of high-power lasers using the calorimetric measurement principle. To perform a measurement, the Cube+'s absorber is exposed to laser radiation for a short period of time. The resulting temperature increase in the absorber is recorded, and the energy input is calculated from this.

At the same time, the Cube+ uses a photodiode to measure the on-time (pulse duration). The power is calculated as the ratio of energy to time.

The measurement principle is insensitive to initial temperature, beam position, and beam size, making it particularly suitable for demanding and customized measurement tasks, such as in plant maintenance.

5.5 On/Off button

The On/Off button has several functions:

Keystroke	Function
Short press	Switch on (The Cube+ takes about 5 seconds to start up)
Short press again	Switch to next screen
2 seconds	Show History screen
2 seconds again	Switch to Ready to Measure screen
5 seconds	Switch off

Tab. 5.1: Functions of the On/Off button

5.6 Display



Fig. 5.2: Optical display

6 Connections

6.1 Overview of connections

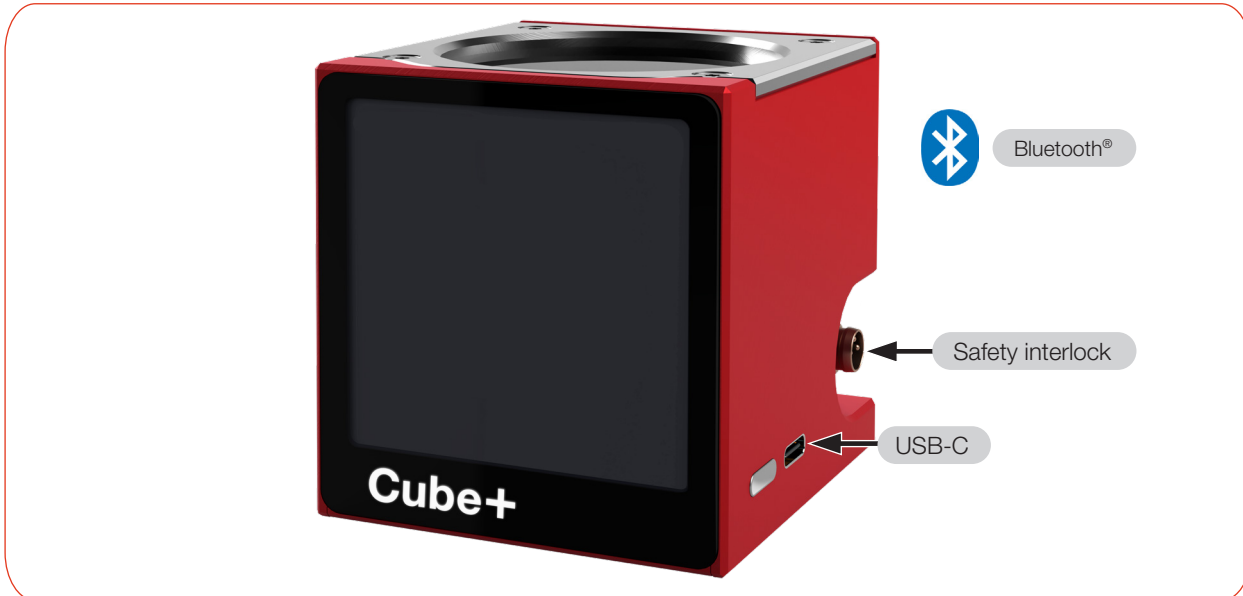

Fig. 6.1: Overview of connections

6.2 USB

The Cube+ features a USB-C port.

The USB port is used to charge the battery and communicate with the LDS.

The Cube+ starts up automatically when the USB cable is plugged in.

<p>The driver usbser.sys is used. This driver is part of the driver packages included with Windows.</p> <p>The driver is installed automatically as soon as the USB port is used, even if this is only for power supply purposes.</p>	
<p>The successful installation will be displayed.</p>	
<p>The Cube+ is displayed in Device Manager as Serial USB Device.</p>	

Fig. 6.2: USB driver installation

6.3 Bluetooth®

A Bluetooth® interface is integrated in the Cube+. This enables a wireless connection with the PC, tablet or smartphone.

First, enable Bluetooth® on your device before turning on the Cube+M. The Bluetooth® feature on the Cube+ M is permanently active once the Cube+ M is turned on.

6.4 Safety interlock



DANGER

Fire hazard; Damage/Destruction of the device

The device has internal safety monitoring. If the safety interlock is not connected, the device may be damaged by overheating or cause a fire.

- ▶ Connect the safety interlock to the safety circuit of the laser control system in such a way that the laser is switched off in the event of faulty operating conditions.
- ▶ Check that the safety interlock will switch off the laser properly in case of error.

The use of the safety interlock protects the Cube+ from damage in many situations. Nevertheless, depending on the parameters of the laser beam to be measured, damage to the absorber may occur.

Please observe the information on minimum and maximum energy input per measurement according to chapter 15 „Technical data“ on page 37.

Due to the time lag in heat distribution, the temperature of the absorber can briefly rise above 120 °C during irradiation. To avoid triggering the safety interlock, the interlock threshold is raised temporarily to 200 °C.

If the temperature of the absorber is above 120 °C after the measurement is completed, the safety interlock is triggered to protect the absorber. This prevents the Cube+ M from being irradiated again.

Pin assignment M8 connector 3-pin (view to plug on device; color: wire colors of the cable)

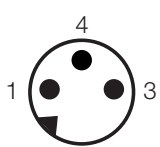
	Pin	color	Function
	1	Brown	Connected to pin 4 when ready for operation
	3	Blue	Connected to pin 4 faulty operating conditions
	4	Black	Common pin

Tab. 6.1: Pin assignment of safety interlock connector

7 Mounting

7.1 Conditions at the installation site

- The Cube+ must not be operated in a condensing atmosphere.
- The ambient air must be free of gases and aerosols that interfere with the laser radiation (e.g. organic solvents, smoke, sulfur hexafluoride).
- Protect the Cube+ from splashes of water and dust.
- Operate the Cube+ in closed rooms only.

7.2 Installation in the laser system

7.2.1 Prepare mounting

1. Switch off the laser beam.
2. Ensure that moving parts, e.g. robot arms, etc. are at a standstill and that they cannot be set in motion unintentionally.

7.2.2 Possible mounting positions

The Cube+ can be mounted in any position.

7.2.3 Align the Cube+

The laser beam should hit the inlet aperture centrally and perpendicularly. Normally, the Cube+ is positioned underneath the focal plane of the beam path. If this is not possible, the Cube+ can be positioned above the focal plane.

Please observe chapter 15 „Technical data“ on page 37:

- the max. beam diameter of 30 mm on the absorber
- the max. permissible power density on the absorber as a function of the beam diameter
- the max. tolerance to the centered beam incidence of ± 2.0 mm
- the max. angle of incidence of $\pm 5^\circ$ perpendicular to the inlet aperture

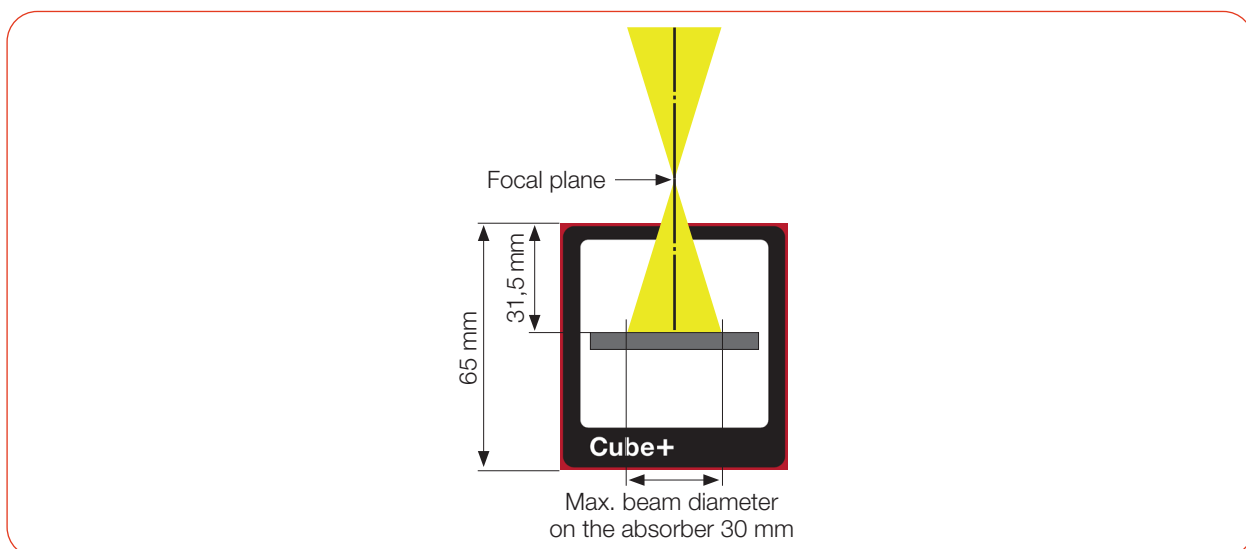

Fig. 7.1: Alignment to the laser beam

7.2.4 Mount the Cube+



DANGER

Serious eye or skin injury due to laser radiation

If the device is moved from its aligned position, increased scattered or directed reflection of the laser beam occurs during measuring operation (laser class 4).

- ▶ Mount the device so it cannot be moved by an unintended push or a pull on the cables or hoses.

NOTICE

Damaging/Destruction of the device

Contamination and fingerprints on the protective window can cause damage or cracking/splintering of the protective window during measuring operation.

- ▶ Do not touch the protective window with bare hands.
- ▶ Regularly check the condition of the protective window. The protective window can be cleaned or replaced (see chapter 12 „Maintenance and service“ on page 33).
- ▶ Only operate the device with a clean protective window.

1. Mount the Cube+ using the mounting threads.
2. Ensure a stable installation of the Cube+. The Cube+ must not be able to move.
3. Connect the safety interlock connection cable.

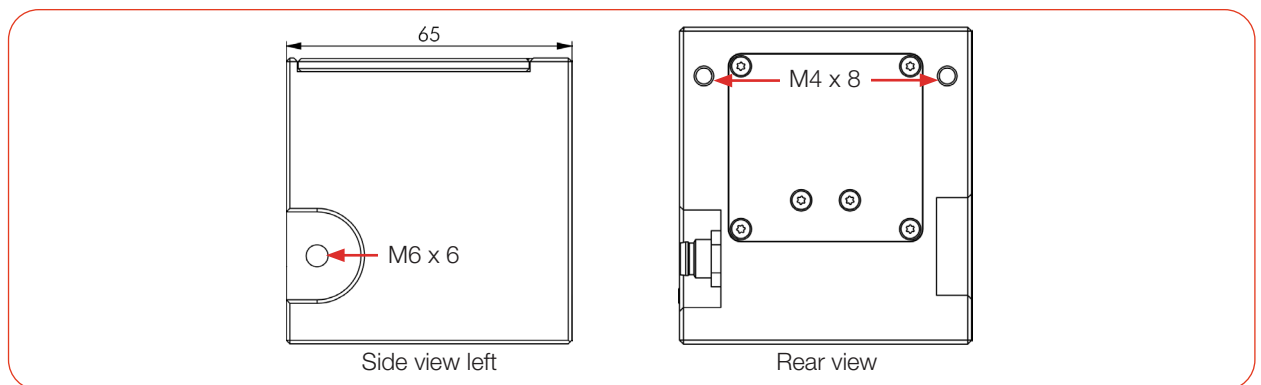

Fig. 7.2: Mounting threads in the housing (dimensions in mm)

7.3 Removal from the laser system

1. Switch off the laser beam.
2. Ensure that moving parts, e.g. robot arms, etc. are at a standstill and that they cannot be set in motion unintentionally.
3. Switch off the Cube+.
4. Disconnect all connections.
5. Unscrew the fastening screws.
6. Remove the Cube+ from the laser system.

8 Software installation

8.1 Install LDS



The LDS is not included in the scope of delivery.
 Information for download at: www.primes.de/en/support/downloads/software.

1. Please ensure:
 - System requirements are met.
 - You have administrator rights.
 2. Close all programs on your PC.
 3. Insert the PRIMES USB flash drive into your PC and open the directory.
 4. Double-click the LDS_Setup.exe file to start the installation.
 5. Follow the instructions on the screen.
- ➔ The default storage location is:
C:\Programs\Primes\LaserDiagnosticsSoftware.

System requirements:

- Intel Pentium Core i3 or better
- Windows 10/11 (64-bit version)
- At least 4 GB RAM; 8 GB RAM recommended
- Display resolution: Full HD (1 920 x 1 080)
- USB-A or Bluetooth

9 Laser parameter setting

9.1 Setting the laser rise time

The applicable irradiation time is between 0.1 s and 2.0 s, which has to be transferred to the laser controller as pulse duration/burst duration. The maximum laser rise time for power measurement must not exceed 1 % of the irradiation time. This limit has to be adhered to in order to avoid incorrect results of the power measurement.

Some laser beam sources are factory set with power ramps of up to a few 100 ms to switch on the laser beam. To achieve a high measuring accuracy the shortest possible rise time has to be set.

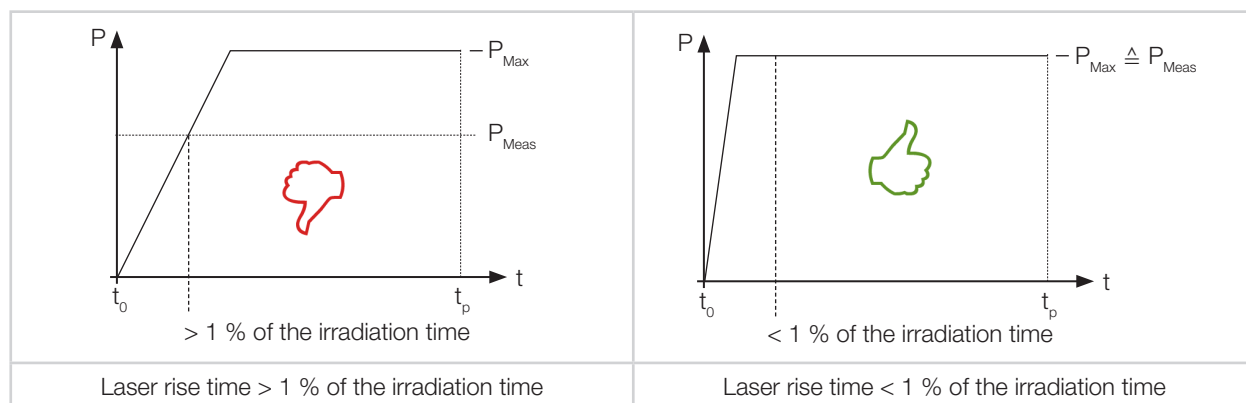

9.2 Maximum permissible power density

To avoid damage to the absorber, the maximum permissible power density at the absorber must not be exceeded. The permissible power densities vary depending on the beam diameter.

A list of the permitted power densities depending on the beam diameter is given in chapter 15 „Technical data“ on page 37.

The power density in kW/cm² is calculated according to the formula:

$$\text{Power density} = \frac{P_{\text{Laser power in kW}}}{\pi \cdot r^2_{\text{Beam radius in cm}}}$$

Formel 9.1: Calculation of the power density

To determine the maximum laser power, the result is weighted with a safety factor of 2. The safety factor compensates the ratio of maximum to average power density of a Gaussian beam (far field). The maximum permissible laser power in kW depending on the beam radius is calculated according to the formula:

$$P_{\text{Laser power in kW}} = \text{max. Power density} \frac{\text{kW}}{\text{cm}^2} \cdot \pi \cdot r^2_{\text{Beam radius in cm}} \cdot \frac{1}{2}$$

Formel 9.2: Calculation of the permissible laser power depending on the beam radius

Example: With a beam diameter of 3 – 1.5 mm, the Cube+ can absorb a maximum power density of 10 kW/cm². For a beam diameter of 3 mm (beam radius 0.15 cm), the maximum permissible laser power is calculated as follows:

$$P \text{ in kW} = 10 \text{ kW/cm}^2 \cdot \pi \cdot 0,15 \text{ cm} \cdot 0,15 \text{ cm} \cdot \frac{1}{2} = 0,353 \text{ kW} = 353 \text{ W}$$

Formel 9.3: Example calculation



For a quick determination of the maximum permissible laser power as a function of the irradiation time or the beam diameter, two diagrams are included in chapter A „Diagrams for determining the max. laser power“ on page 39.

9.3 Minimum and maximum energy input per measurement

The measured temperature rise in the absorber is decisive for an accurate and reproducible measurement. Regardless of the starting temperature, we recommend an energy input of approx. 300 J per measurement.

Example: At 1 kW laser power the recommended pulse duration is 300 ms.

$$E = P \cdot t = 1\,000\text{ W} \cdot 0.3\text{ s} = 300\text{ J}$$

Fig. 9.1 shows the permissible energy input for a measurement as a function of the absorber temperature.

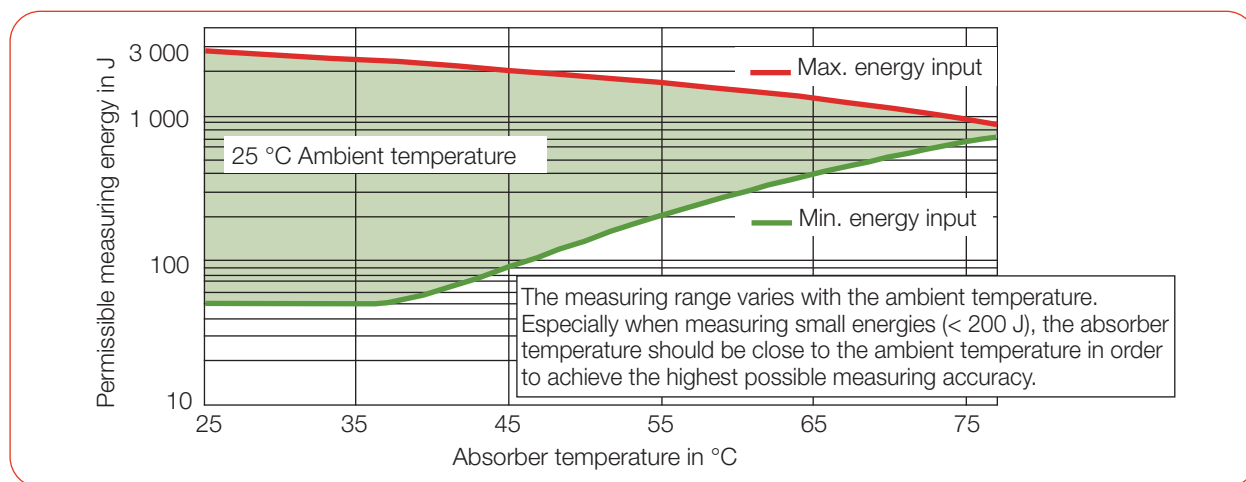

Fig. 9.1: Measuring range as a function of the absorber temperature

The minimum energy input indicates the lower limit values at which measurements can still be performed within the specified accuracy. The maximum energy application value specifies the limit at which the absorber reaches its permissible limit temperature. The energy, e.g. for multiple measurements (serial measurements) can be distributed across the range shown in green.

If the absorber temperature is higher than 100 °C, no further measurement should be performed. In this case, please wait until the absorber temperature has fallen below 50 °C (depending on the selected energy input). Please take the limit values from Fig. 9.1 and Tab. 9.1.

Absorber temperature in °C	Min. energy input in J	Max. energy input in J
20	50	3 000
25	50	2 800
30	50	2 600
35	50	2 400
40	60	2 200
45	90	2 100
50	140	1 900
55	200	1 700
60	290	1 500
65	390	1 300
70	520	1 100

Tab. 9.1: Absorber temperature with energy input (ambient temperature 20 °C)

9.4 Waiting times until the next measurement in serial measurements

Please note that at high measuring frequencies the measuring accuracy may be limited.

For serial measurements within the specified accuracy, the following waiting times are recommended before the next measurement.

Energy input in J	Waiting time in s
200	50
400	100
600	150
800	200
1 000	250

Tab. 9.2: Waiting times until the next measurement in serial measurements

9.5 Measurement with pulsed lasers

When using pulsed laser radiation a correct exposure time measurement is possible up to a pulse frequency of 10 kHz and a duty cycle of 50 %. In case of on/off time shorter than 50 µs a correct exposure time measurement is not possible.

With pulsed lasers, the Cube+ recognizes the number of pulses n and the number of pulse pauses $n-1$. The last pulse pause t_{off} is not measured for physical reasons. This leads to an increased display of the average power with a low number of pulses. The average power is corrected on the basis of the corrected burst duration (see Fig. 9.2).

For cw lasers and lasers with one pulse, the average power corresponds to the maximum power of one pulse.

When measuring pulsed lasers, the technical specification according to chapter 15 „Technical data“ on page 37 must be observed.

Measurements outside the specification may result in an incorrect calculation of the number of pulses. This affects the calculated pulse power. But not on the calculated average laser power and energy.

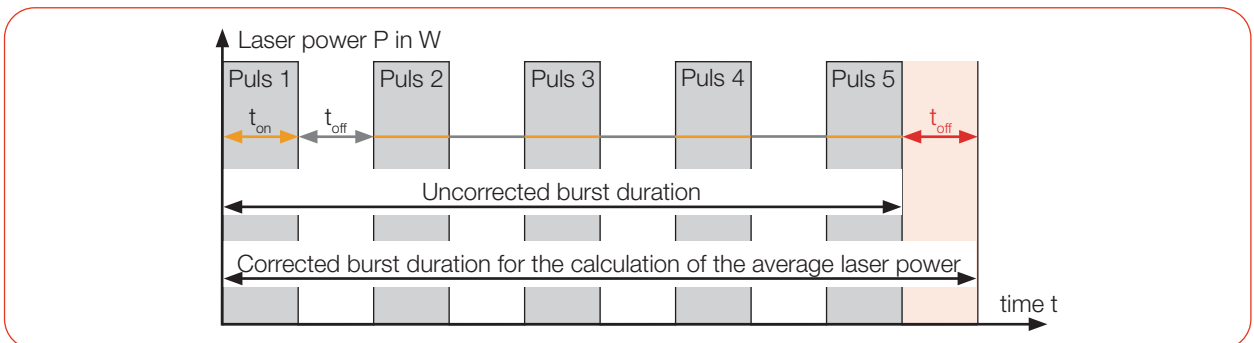

Fig. 9.2: Uncorrected and corrected burst duration with pulsed lasers

10 Measure

10.1 Warning messages



DANGER

Serious eye or skin injury due to laser radiation

During the measurement the laser beam is guided on the device. This causes scattered or directed reflection of the laser beam (laser class 4). The reflected beam is usually not visible. The device must not be operated without taking the following precautions:

- ▶ Wear **safety goggles** adapted to the power, power density, laser wavelength and operating mode of the laser beam source in use..
- ▶ Wear suitable **protective clothing** and **protective gloves**.
- ▶ Protect yourself from laser radiation by separating protective devices (e.g. by using appropriate shielding).



DANGER

Serious eye or skin injury due to laser radiation

If the device is moved from its aligned position, increased scattered or directed reflection of the laser beam occurs during measuring operation (laser class 4).

- ▶ Mount the device so that it cannot be moved by an unintended push or a pull on the cables or hoses.



DANGER

Fire hazard; Damage/Destruction of the device

The safety interlock monitors the operating conditions of the device. The safety interlock offers potential-free switch contacts for integrating the device into an existing safety circuit.

- ▶ Connect the safety interlock of the laser control unit in such a way that in the event of faulty operating conditions the laser is switched off.
- ▶ Check that the safety interlock will switch off the laser properly in case of error.

NOTICE

Damaging/Destruction of the device

The alignment tool will be destroyed by laser radiation.

- ▶ Remove the alignment tool before switching on the laser.

10.2 Measuring as stand-alone-device

10.2.1 Start measurement

1. Press the On/Off button.
- 👁️ After 5 seconds, the **Bootup-Logo** displays.

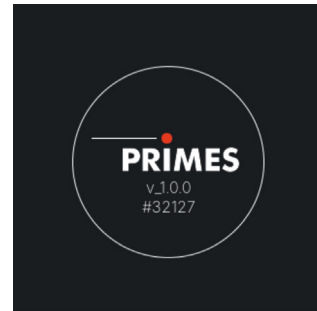

- 👁️ The **Ready to Measure** screen will appear.
- ▶ Please read chapter 9 „Laser parameter setting“ on page 18 first.
2. Switch on the Laser.
- ▶ The measurement is started automatically.
- 👁️ The temperature and capacity of the absorber are displayed continuously.

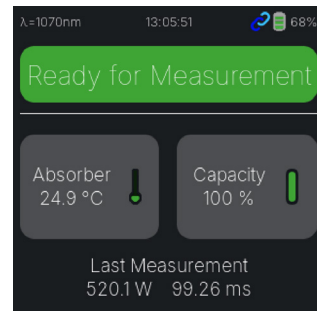

- 👁️ **Please wait** is displayed during the measurement.

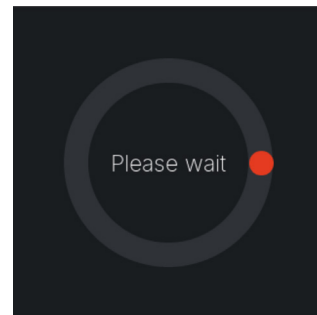

- 👁️ The readings are then displayed for a few seconds.
- After a few seconds, the display will return to the **Ready to Measure** screen.



- ▶ If the absorber temperature is higher than 100 °C, no further measurement should be performed. Please wait until the absorber temperature has fallen below 70 °C. Please take the limit values from on page 14 and on page 14.

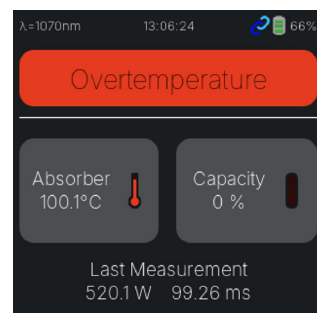

▶ Press the On/Off button briefly to access the **Results** screen:

- Timestamp
- Energy in J
- Number of pulses
- Exposure Time in ms
- On Time in ms
- Off Time in ms
- Average Power in W
- Pulse Power in W

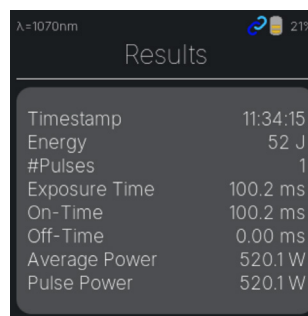

▶ Press the On/Off button briefly to return to the **Ready to Measure** screen.



▶ Press the On/Off button for 2 seconds to access the **History** screen.

👁️ The Timestamp, Power (W) und Time (ms) of the last 8 measurements are displayed.

- For previous readings press the On/Off button briefly.
- The last 32 readings can be displayed.



▶ Press the On/Off button for 2 seconds again to access the **Ready to Measure** screen.



▶ Press and hold the On/Off button for 5 seconds to turn off the Cube+.

- By default, the Cube+ switches off automatically after approx. 10 minutes, if no USB cable is connected.
- The time can be set via the LDS or the SpotLight App.



10.3 Measuring with the LDS

10.3.1 Connect/disconnect the Cube+ with the LDS

1. Observe chapter 9 „Laser parameter setting“ on page 18
2. Observe chapter 10.1 „Warning messages“ on page 22.
3. Press the On/Off button on the Cube+.
4. Connect the Cube+ via Bluetooth® (see chapter 6.3 „Bluetooth®“ on page 15) or the USB cable with a PC.
5. Start the LDS by double-clicking on the program icon .

 The start screen is displayed.

6. Select the operating mode **Measure**.

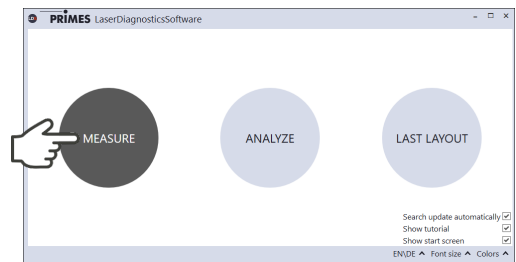

 The **Connections** window is displayed.

7. Click on the desired Cube+.
8. Click the **Connect to device** button.

If the Cube+ does not appear:

- ▶ Check chapter 11.2 „Connection failures“ on page 32.

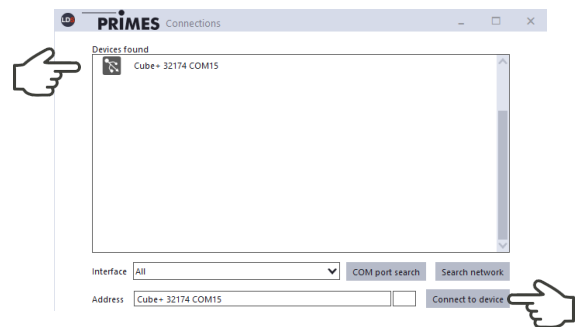

If the **Show start screen** option is disabled or the window **Connections** is closed:

- ▶ Click the **Devices** tab and then the **+ Connect to device** button.

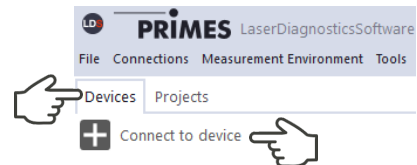



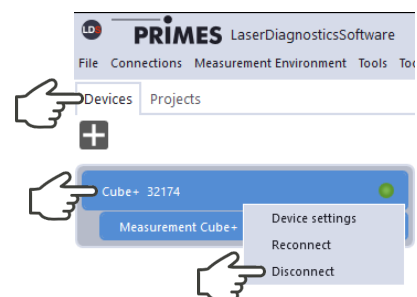

Disconnect the Cube+ from the LDS and switch off

1. Click the **Devices** tab.
 2. Right-click the Cube+ and select **Disconnect**.
- ▶ The Cube+ is disconnected from the LDS.



10.3.2 Settings in the device control

Option	Explanation
New measurement	<ul style="list-style-type: none"> Click this button to create a new series in the project tree. The measurement starts when the laser is switched on.
Wavelength in nm	<p>The Cube+ is calibrated to 1 070 nm (within delivery), additional wavelengths can be validated as an option..</p> <ol style="list-style-type: none"> Select a wavelength. Click the Save settings button.
Inert gas mode	<p>With the inert gas mode, the possible influence of the thermal conductivity of the gas used on the measurement process is typically reduced by 2/3. Helium and argon, in particular, have significantly lower thermal conductivity than air.</p> <ul style="list-style-type: none"> Set the check mark to enable the option. <div style="background-color: #f0f0f0; padding: 5px; margin-bottom: 5px;"> <p> The Cube+ is not suitable for use within a nitrogen atmosphere.</p> </div> <div style="background-color: #f0f0f0; padding: 5px;"> <p> The readings obtained using the LDS in shielding gas mode are not transmitted to the Cube+. Therefore, when shielding gas mode is active, the LDS display will differ from the readings on the Cube+.</p> </div>
Trigger level (Laser power)	<p>Setting the trigger level enables the sensitivity of the built-in photodiode to be adjusted:</p> <ul style="list-style-type: none"> The Low setting is recommended for measuring low laser powers and pulsed laser beams. The High setting prevents false triggering due to environmental influences. <ol style="list-style-type: none"> Select a Trigger level. Click the Save settings button. <div style="background-color: #f0f0f0; padding: 5px; margin-top: 5px;"> <p> If the Trigger level is set too low, a measurement can be triggered even without a laser beam.</p> <p> If the Trigger level is set too high, no measurement can be triggered.</p> </div>
Turn off lighting after	<p>The time after which the Cube+'s lights turn off automatically.</p> <ol style="list-style-type: none"> Select a time from the drop-down list. Click the Save settings button.
Power off device after	<p>The time after which the Cube+ switches off automatically.</p> <ol style="list-style-type: none"> Select a time from the drop-down list. Click the Save settings button. <div style="background-color: #f0f0f0; padding: 5px; margin-top: 5px;"> <p> When the USB cable is connected, the Cube+ cannot be switched off automatically.</p> </div>
Save settings	By pressing the button, the selected settings are transferred to the Cube+.
Load measurements	By pressing the button, the measurements stored in the Cube+ are read out from the Cube+ memory.
Clear history	By pressing the button, the measurements stored in the Cube+ are deleted.

Tab. 10.1: Settings in the device control

10.3.3 Start measurement

The measurement in the Cube+ starts automatically when the laser is switched on. The **Start** display field is therefore not active.

A measuring cycle (measure, thermalize, send data) takes approx. 15 seconds. The Cube+ is then ready for a new measurement.

To create a new series in the project tree, press the **New measurement** button.

1. Observe chapter 9 „Laser parameter setting“ on page 18.
 2. Observe chapter 10.1 „Warning messages“ on page 22.
 3. Enter the settings according to chapter 10.3.2 „Settings in the device control“ on page 26.
 4. Switch on the laser.
- 👁 The progress of the measurement is indicated in the **Measurement is running** and then **Measurement is finished** displays.
5. Switch off the laser.

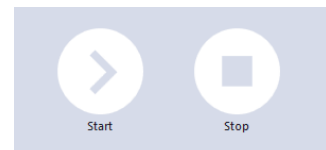
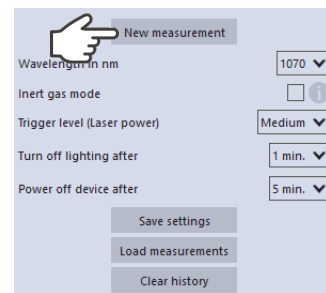

Status

- Ready for measurement
- Measurement is running
- Measurement finished

10.3.4 Measuring results display

Display the current measurement in the toolbench Cube Measurement

👁 The **Cube measurement** toolbench opens automatically when connected.

If the **Cube measurement** toolbench has been closed:

- ▶ Click on **Open measurement toolbench** in the device control panel.
- 👁 After the measurement is finished, the measurement results are displayed in the **Cube measurement** toolbench. For all tools, the displayed parameters can be adjusted by clicking the gear symbol .

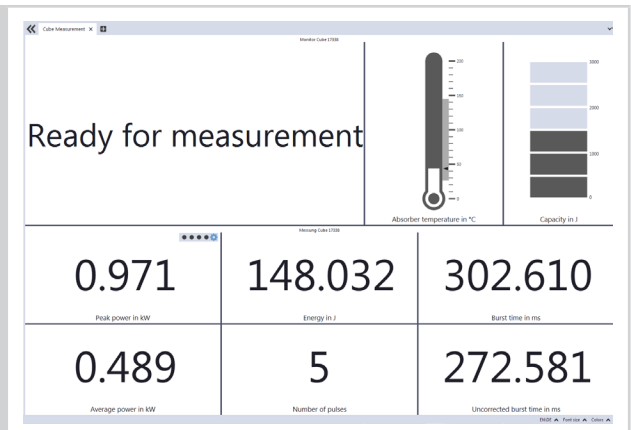

Display of the measurements performed with the LDS

1. Switch to the **Projects** tab.
 - 👁️ The measurements are displayed in the project tree.
- Date, time and order of the displayed measurements:**
2. Move the mouse pointer over the measurement.
 - 👁️ The window displays date and time of the measurement.
 - 👁️ When measuring with the LDS, the measurements are displayed with increasing numbering (last/current measurement has the highest value).

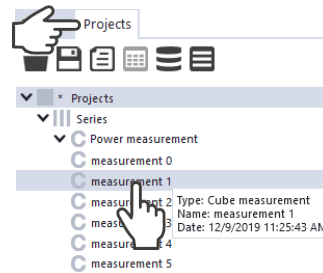

- In the project tree, the used **Inert gas mode** is indicated.
- ▶ Move the mouse pointer over the measurement.
 - 👁️ **Inert gas mode was used** is displayed in the window.

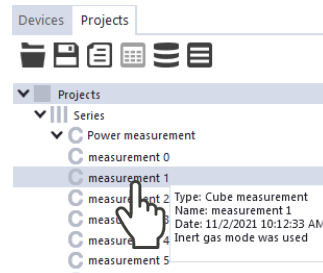

Display of the measurements stored in the Cube+

1. Press the **Load measurements** button
 - ➔ The last 32 measurements stored in the Cube+ are read out of the memory.

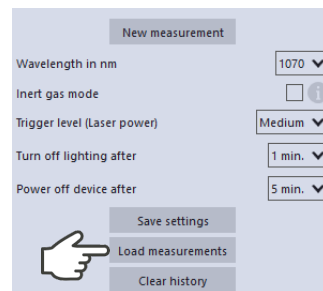

2. Switch to the **Projects** tab.
 - 👁️ The uploaded measurements are displayed in the project tree.
- Date, time and order of the displayed measurements:**
3. Move the mouse pointer over the measurement.
 - 👁️ The window displays the date and time of the upload.
 - 👁️ Uploaded measurements are displayed in a descending order (last measurement is referred „measurement 0“).

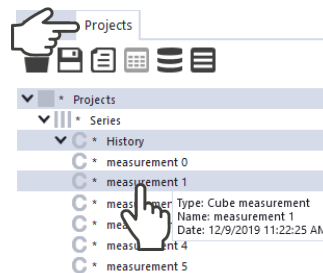

Evaluate measured values with the LDS tools

- Click the **Power measurement** selection in the drop-down list.

👁️ The **Graph**, **Results table** and **Measurement value display** tools are displayed. The **Power measurement** tool is not relevant for the Cube+.

- Open the desired tool and drag and drop the measurements from the project tree into the opened tool.

👁️ For all tools, the displayed parameters can be adjusted by clicking the gear symbol . For example, the rows/columns in the **Results table** can be swapped. For uploaded measurements from the Cube+, the numbering is descending (last/most recent measurement is referred „measurement 0“). When measuring with the LDS, the measurements are displayed with increasing numbering (last/current measurement has the highest value). The “Help”-function of the LDS can be accessed by clicking on the question mark - - - in the toolbar of the tool windows. For a detailed description of the software installation, file management and evaluation of the measured data, please refer to the separate operating manual “LDS”.

measurement	Number of pulses	Energy in J	Power in W	Peak power in W	Burst time in ms
measurement 0	0	0	0	0	0
measurement 1	0	0	0	0	0
measurement 2	0	0	0	0	0
measurement 3	12	555.793	299.037	299.037	1992.373
measurement 4	4	399.33	299.128	299.128	1334.96
measurement 5	81	392.265	297.763	297.76	1992.371
measurement 6	128	356.603	388.294	388.362	996.163
measurement 7	97	389.627	391.119	391.173	996.184
measurement 8	57	390.458	391.994	392.006	996.182
measurement 9	575	160.027	80.318	80.607	1992.406
measurement 10	304	102.643	80.316	80.584	1277.978
measurement 11	694	156.733	78.665	79.057	1992.398
measurement 12	561	254.937	85.303	85.467	2088.659
measurement 13	0	0	0	0	0
measurement 14	0	0	0	0	0
measurement 15	0	0	0	0	0
measurement 16	0	0	0	0	0
measurement 17	1273	367.356	184.361	185.072	1992.379



10.3.5 Delete measurements

The Cube+ stores the measurements in an internal memory.

- ▶ Click the **Clear history** button and confirm.
- ▶ The measurements in the Cube+ are deleted.

10.4 Measuring with the optional SpotLight app

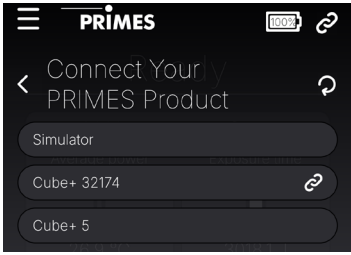
Our new SpotLight App brings powerful measurement visualization and analysis to your fingertips, now available for Android™ and iOS. Connect via Bluetooth® and monitor your data in real time on your smartphone or tablet.

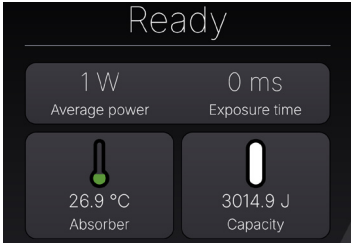
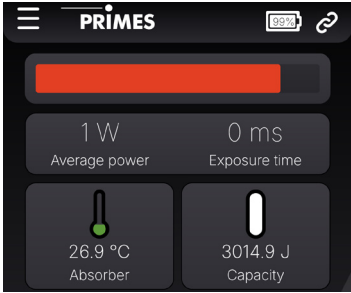
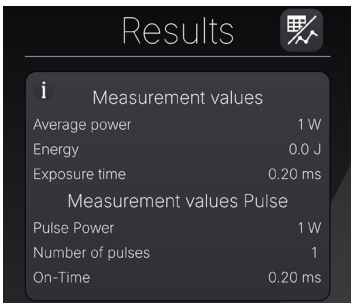
<p>The PRIMES SpotLight app is available for free in the Apple App Store and Google Play Store.</p> <p>► After downloading and launching the app, select a Cube+.</p>	
<p>The following settings can be changed:</p> <ul style="list-style-type: none"> • Wavelength • inert gas mode • Turn off lighting after • Power off device after • Trigger level (Laser power) <p>For a description of the settings, see chapter 10.3.2 „Settings in the device control“ on page 26.</p>	
<p>👁️ Go to the Ready screen.</p> <p>3. Switch on the laser.</p> <p>➔ The measurement will start automatically.</p>	
<p>👁️ An ongoing measurement is indicated by a red progress bar.</p> <p>👁️ The temperature and capacity of the absorber are displayed continuously.</p>	
<p>The following measurements are displayed:</p> <ul style="list-style-type: none"> • Average power in W • Energy in J • Exposure time in ms • Pulse Power in W • Number of pulses • On-Time in ms 	

11 Troubleshooting

11.1 LDS messages during measurement

If problems occur during a measurement, the LDS displays them in different categories and colors.

Note

Notes provide assistance in interpreting the measurement results and are displayed in a blue window.

Use one of the following options:

- ▶ Click on the warning triangle in the footer to display / hide the window.
- ▶ If applicable, click the **Next message** button to display more messages of the same category.
- ▶ Click the **Confirm** button to remove the displayed message.

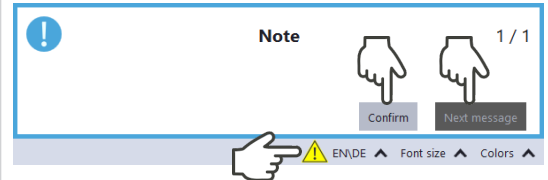

Warning

Non-safety-critical problems that influence the quality of the measurement results, for example, are displayed in a yellow window.

Use one of the following options:

- ▶ Click on the warning triangle in the footer to display / hide the window.
- ▶ If applicable, click the **Next message** button to display more messages of the same category.
- ▶ Click the **Confirm** button to remove the displayed message.



Device error

Device errors that can result in damage of the device are displayed in an orange window.

In this case, proceed as follows:

1. Fix the problem.
2. Click the **Confirm** button to remove the message.
- 👁️ The message disappears. If the problem is not fixed, then the message appears again shortly afterwards.
3. Do not proceed with the measurement until the problem is solved.



Safety critical note

Safety-critical problems that can result in damage/destruction of the device are displayed in a red window.

In this case, proceed as follows:

1. Fix the problem immediately.
2. Click the **Confirm** button to remove the message.
- 👁️ The message disappears. If the problem is not fixed, then the message appears again shortly afterwards.
3. Do not proceed with the measurement until the problem is solved.



Tab. 11.1: LDS messages

11.2 Connection failures

Error	Possible cause	Solution
Bluetooth® connection cannot be established.	No Bluetooth® connection is established.	▶ Connect the Cube+ to the PC according to chapter 6.3 „Bluetooth®“ on page 15.
	Bluetooth® of the PC is not activated.	▶ Activate Bluetooth® according to chapter 6.3 „Bluetooth®“ on page 15.
USB connection cannot be established.	No USB connection is established.	▶ Connect the Cube+ with the USB cable to the PC.
	The PRIMES USB driver was not installed.	▶ Install the USB driver according to chapter 6.2 „USB“ on page 14.

Tab. 11.2: Connection failures

11.3 Other errors

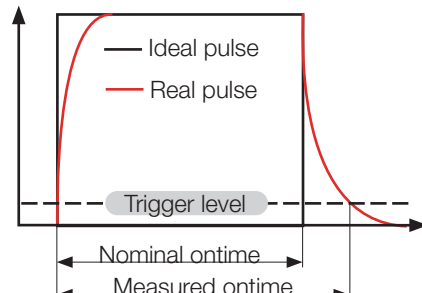
Error	Possible cause	Solution
A measurement is started without the laser beam switched on.	The Trigger level is set too low.	▶ Select a higher Trigger level .
A measurement cannot be triggered.	The Trigger level is set too high.	▶ Select a lower Trigger level .
A pulsed laser beam cannot be measured.	Not enough energy is put into the absorber.	When using pulsed laser radiation a correct exposure time measurement is possible up to a pulse frequency of 10 kHz and a duty cycle of 50 %. In case of on/offtimes shorter than 50 µs a correct exposure time measurement is not possible. ▶ Observe the min. on/offtime (duty cycle) for pulsed lasers of 50 µs (e.g. max. 10 kHz at 50 % duty cycle).
Too many pulses are displayed.	Additional erroneous pulses (needle tips).	▶ Select a different Trigger level .
The measured ontime is longer than the set nominal ontime.	The real pulse does not correspond to an ideal square wave signal.	 ▶ Select a higher Trigger level .
The displayed laser power is too low.	The beam diameter at the inlet aperture is too large.	▶ Align the Cube+ according to chapter 7.2.3 „Align the Cube+“ on page 16 .
	The laser beam hits the inlet aperture only partially.	
	The laser rise time exceeds 1 % of the irradiation time.	Detailed information on the laser rise time can be found in chapter 9.1 on page 18. ▶ Set the shortest possible laser rise time.
The timestamp shows the wrong time.	The laser power does not correspond to the actual emitted laser power.	When properly aligned and used, the calibrated PRIMES measuring device provides reliable measured values. ▶ Increase the set power on the laser. ▶ Repeat the power measurement.
	Change of time zone. Daylight Saving Time change.	Connect the Cube+ to LDS or SpotLight once to sync it with the time zone set on your PC or phone.

Tab. 11.3: Other errors

12 Maintenance and service

12.1 Maintenance intervals

The operator is responsible for determining the maintenance intervals of the Cube+. PRIMES recommends a maintenance interval of 12 months after initial operation for inspection and calibration. If the Cube+ is used sporadically (less than once a day), the maintenance interval can be extended up to 24 months.

Please note that the safety and warning functions must be checked regularly.

12.2 Cleaning

Cleaning the device surface

1. After a measurement let the Cube+ cool down for an adequate period of time.
2. First clean the device surface with clean and oil-free compressed air.
3. For further cleaning, use a mixture of distilled water and isopropanol in a ratio of approx. 5:1. Use lint-free cleaning cloths that do not cause scratches.
4. If these steps are not sufficient, please contact PRIMES or your PRIMES distributor.

12.3 Protective window



CAUTION

Burns due to hot components

The protective window is hot after a measurement.

- ▶ Do not clean or change the protective window directly after a measurement.
- ▶ Let the device cool down for an adequate period of time.

NOTICE

Damaging/Destruction of the device

Contamination and fingerprints on the protective window can cause damage or cracking respectively splintering of the protective window during measuring operation.

- ▶ Only clean or change the protective window in a dust-free environment.
- ▶ Do not touch the protective window with bare hands, wear suitable gloves.

NOTICE

Damaging/Destruction of the device

If the protective glass is not installed correctly, it may shatter or crack.

- ▶ Ensure that the protective window is positioned evenly in the indentation on the O-ring.

Cleaning the protective window

i The coating of the protective window is particularly sensitive to scratches. Use cloths suitable for cleaning protective glasses.

1. After a measurement let the Cube+ cool down for an adequate period of time.
2. Dismount the protective window according to chapter „Exchanging the protective window“ on page 34.
3. First clean the protective window with cleaned, oil-free compressed air.
4. For further cleaning, use isopropanol (observe the manufacturer’s safety instructions).
5. Replace the protective window with a new one if the contamination cannot be removed or if it is damaged.
6. Mount the protective window according to chapter „Exchanging the protective window“ on page 34.

Exchanging the protective window

i The protective window is coated with an anti-reflective coating and has low reflectance values of less than 1 %. To avoid increased reflection, use only original PRIMES protective windows. For more information please get in touch with your PRIMES contact.

1. After a measurement let the Cube+ cool down for an adequate period of time.
2. Put on suitable gloves.
3. Unscrew the 4 Torx screws M2.5 x 6 mm on the protective window mount.
4. Carefully remove the protective window mount upwards.
5. Remove the protective window from the Cube+.
6. Insert the protective window into the Cube+. Ensure that the inserted O-ring is not out of place.
7. Place the protective window mount and tighten with 4 Torx screws M2.5 x 6 mm.
8. Check for secure fit of the protective window mount. The protective window mount must rest flat.

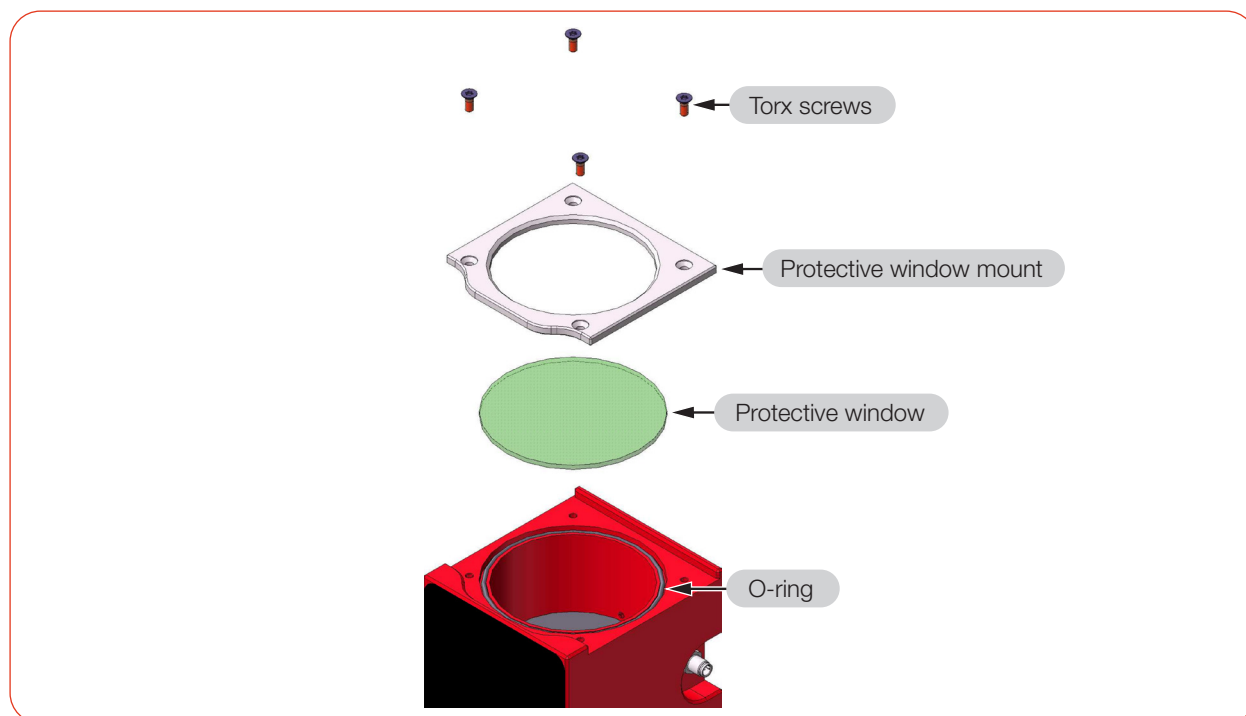

Fig. 12.1: Exchanging the protective window

13 Measures for the product disposal

This PRIMES measuring device is subject to the Directive 2012/19/EU on Waste Electrical and Electronic Equipment (WEEE) and the corresponding national laws.

The WEEE obliges the operating company to dispose of the device in an environmentally sound manner, not with household waste, but in a separate WEEE collection.

PRIMES gives the opportunity to return PRIMES measuring devices for free disposal within the scope of the WEEE. This service does not include shipping costs.

PRIMES measuring devices to be disposed of within the EU can be send to the following address:

PRIMES GmbH
Max-Planck-Str. 2
64319 Pfungstadt
Germany

If you are located outside the EU, please contact your local PRIMES distributor to discuss the disposal procedure for your PRIMES measuring device.

PRIMES is registered with the german „stiftung elektro-altgeräte register“ foundation (stiftung ear) as a manufacturer under the number: WEEE Reg. No. DE65549202.



To process your return as efficiently as possible, please fill out our return form. You can find the form using the QR code opposite or at: www.primes.de/en/create-rma-online.



Caution battery included!

Please note that there is a permanently installed lithium-ion battery in the device.

It must be disposed of in accordance with applicable national and international laws if the device is not returned to PRIMES.

14 Declaration of conformity



EU Declaration of Conformity

The manufacturer: PRIMES GmbH, Max-Planck-Straße 2, 64319 Pfungstadt, Germany hereby declares, that the device with the designation:

Cube+

is in conformity with the following EU Directives:

- Radio Equipment Directive 2006/53/EU
- EMC Directive 2014/30/EU
- RoHS Directive 2011/65/EU

Following harmonized standards have been applied:

DIN EN ISO 12100:2011-03	Safety of machinery - General principles for design - Risk assessment and risk reduction
DIN EN 61010-1:2020-03	Safety requirements for electrical equipment for measurement, control, and laboratory use - Part 1: General requirements
DIN EN IEC 61326-1:2022-11	Electrical equipment for measurement, control and laboratory use - EMC requirements - Part 1: General requirements
DIN EN IEC 62680- 1-3: 2023-05	Universal serial bus interfaces for data and power - Part 1-3: Common components
DIN EN IEC 63000:2018	Technical documentation for the assessment of electrical and electronic products with respect to the restriction of hazardous substances

Authorized for the documentation:

PRIMES GmbH, Max-Planck-Str. 2, 64319 Pfungstadt

Pfungstadt, May 6, 2026

Dr. Reinhard Kramer, CEO

15 Technical data

Measurement parameters		Cube+
Power range		25 – 12 000 W ¹⁾
Wavelength range (see identification plate)		440 – 460 nm, 510 – 540 nm, 800 – 1100 nm
Max. beam diameter on the absorber		30 mm
Max. power density on the absorber at beam diameters (approx. 30 mm underneath the protective window)	> 10 mm	4 kW/cm ²
	10 – 3 mm	5 kW/cm ²
	3 – 1.5 mm	10 kW/cm ²
	< 1.5 mm	12 kW/cm ²
Irradiation time		0.1 – 2.0 s ¹⁾ (depending on laser power)
Min. on/off time (duty cycle) for pulsed lasers		50 µs (e.g. max. 10 kHz at 50 % duty cycle)
Max. laser rise time		< 1 % of irradiation time
Energy per measurement		50 – 3 000 J
Recommended energy per measurement		300 – 500 J
Total duration until measurement value output		< 15 s
Nominal measurement frequency		300 J: 1 cycle/min; 3 000 J: 1 cycle/15 min
¹⁾ The stated limit values are to be understood in correlation with the permitted maximum energy ($E = P \cdot t$).		
Device parameters		
Max. absorber temperature		120 °C
Max. angle of incidence perpendicular to inlet aperture		± 5°
Max. centered tolerance		± 2.0 mm
Reproducibility		± 1 %
Measurement accuracy with 1 070 nm calibration		
NIR laser (800 – 1100 nm)		± 3 %
Green laser (510 – 540 nm)		± 3,5 %
Blue laser (440 – 460 nm)		± 4 %
Measurement accuracy validated at 515 nm		
Green laser (510 – 540 nm)		± 3 %
Blue laser (440 – 460 nm)		± 3,5 %
Supply Data		
Power supply		Built-in lithium-ion battery, 1 800 mAh
Maximum charging power		5 V – 1 A
Communication		
Interfaces		USB-C; Bluetooth® Version: 5.2
Software (optional)		SpotLight Android/iOS App and LDS
Dimensions and Weight		
Abmessungen (LxBxH) (ohne Anschlüsse)		60 x 65 x 65 mm
Gewicht (ca.)		500 g
Environmental Conditions		
Operating temperature range		15 – 40 °C
Storage temperature range		5 – 50 °C
Reference temperature		22 °C
Permissible relative humidity (non-condensing)		10 – 80 %

16 Dimensions

Dimension in mm

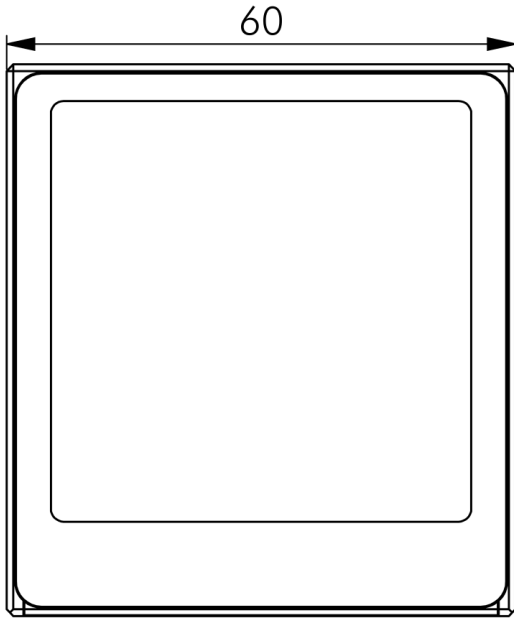

Front view

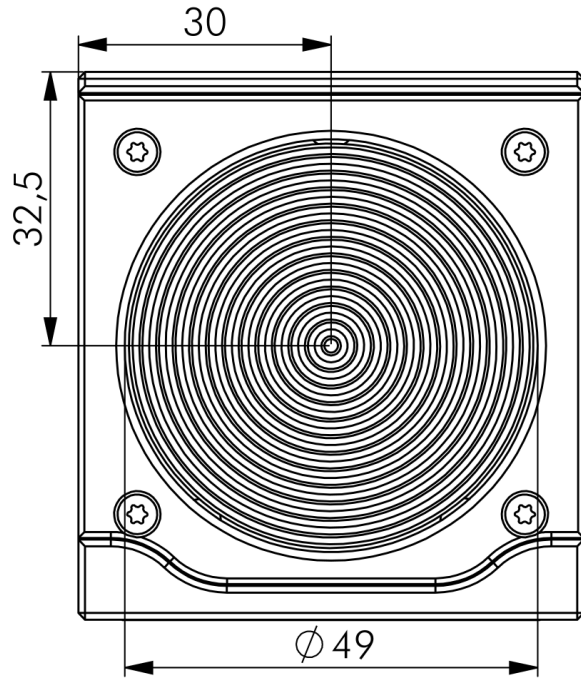

Top view

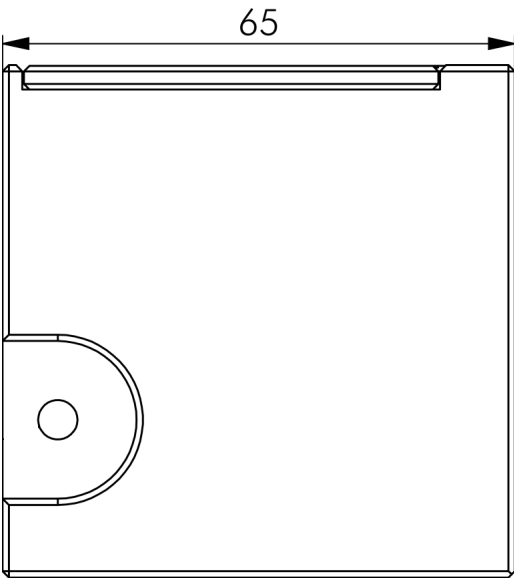

Side view L

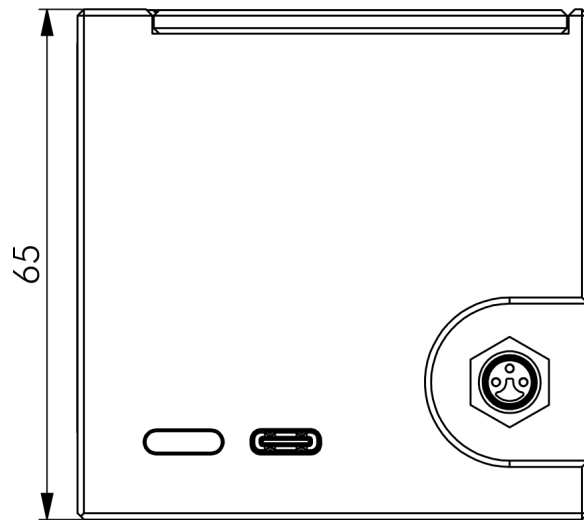

Side view R

17 Appendix

A Diagrams for determining the max. laser power

Max. laser power depending on the irradiation time

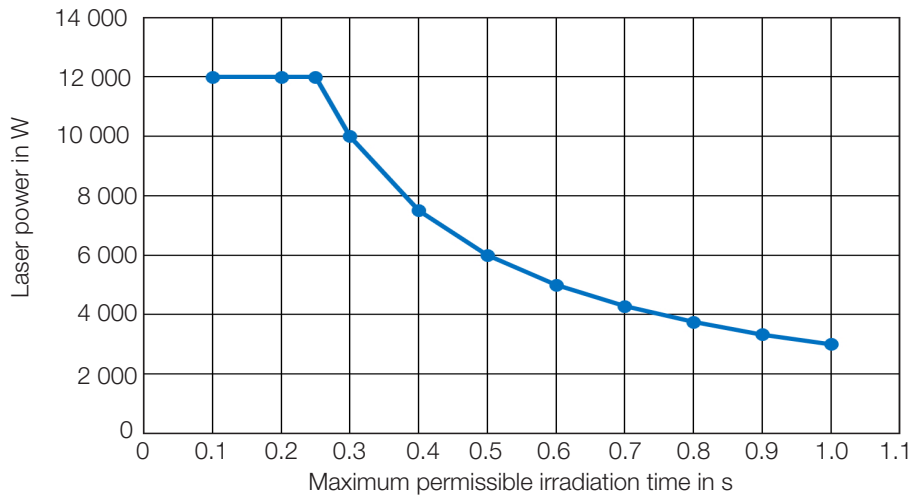

Max. laser power depending on the beam diameter

